



IRON & STEEL PLANTS

SOLUTIONS FOR INDUSTRIAL AUDIO & VIDEO SYSTEMS REQUIREMENTS

SOLUTIONS FOR IRON&STEEL



HIGH TEMPERATURE CAMERA SYSTEM



INDUSTRIAL CCTV SYSTEMS



INDUSTRIAL AUDIO COMMUNICATION



THERMOGRAPHIC SYSTEMS



HIGH TEMPERATURE CAMERA SYSTEMS

APPLICATIONS

- **Melt Shop:** EAF Furnace, EAF COOLING PANELS, (Ladle Furnace) LF, VOD, EBT Tapping;
- **Continuous Casting:** Tundish Car, Mould, Cooling Bed, Quality Control, Cutting;
- **Rolling Mill:** RHF, Heat Treatment and Annealing;

ELECTRICAL ARC FURNACE (EAF) APPLICATIONS

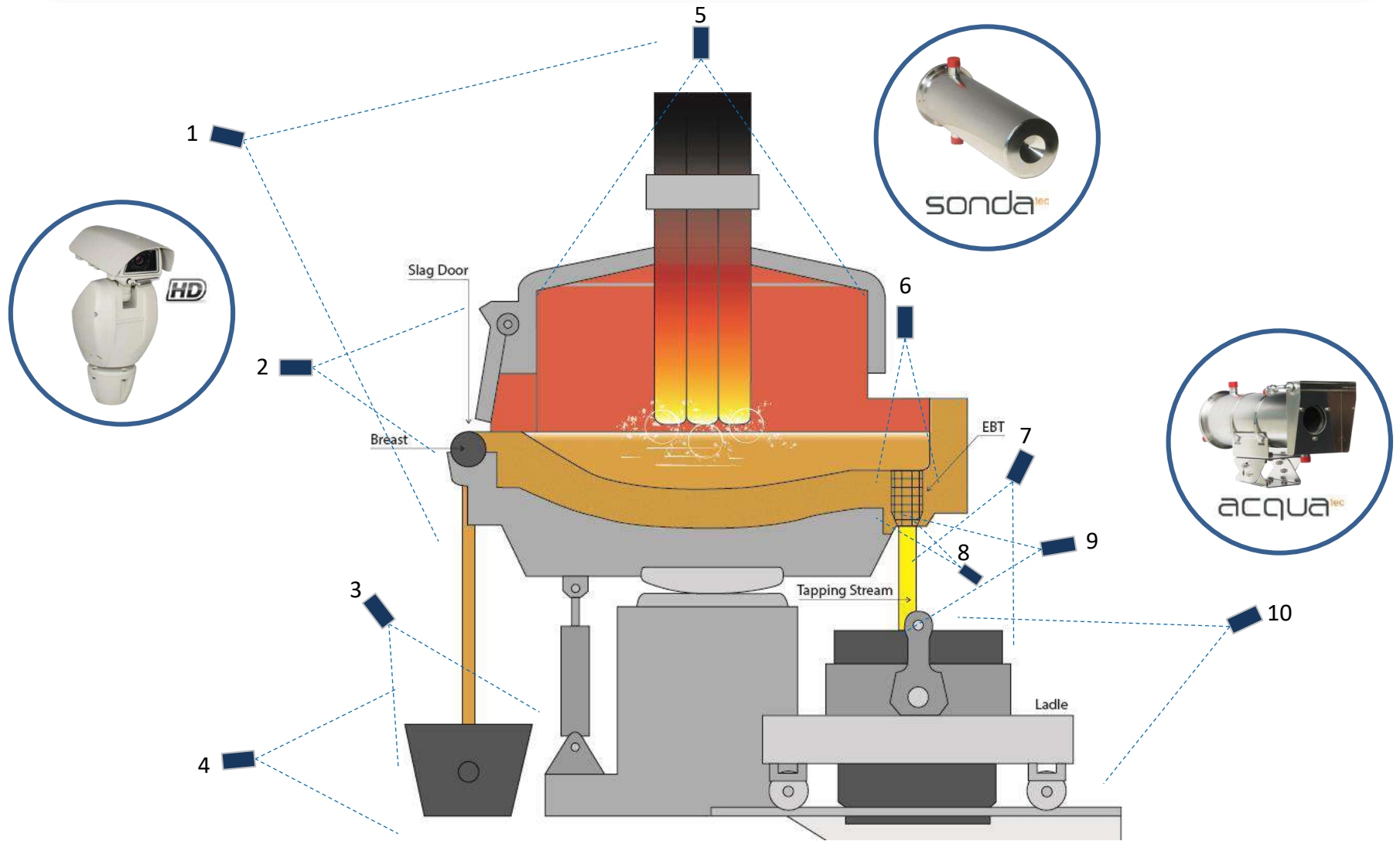

GENERAL OVERVIEW (EAF)



Video



1

Slag Door

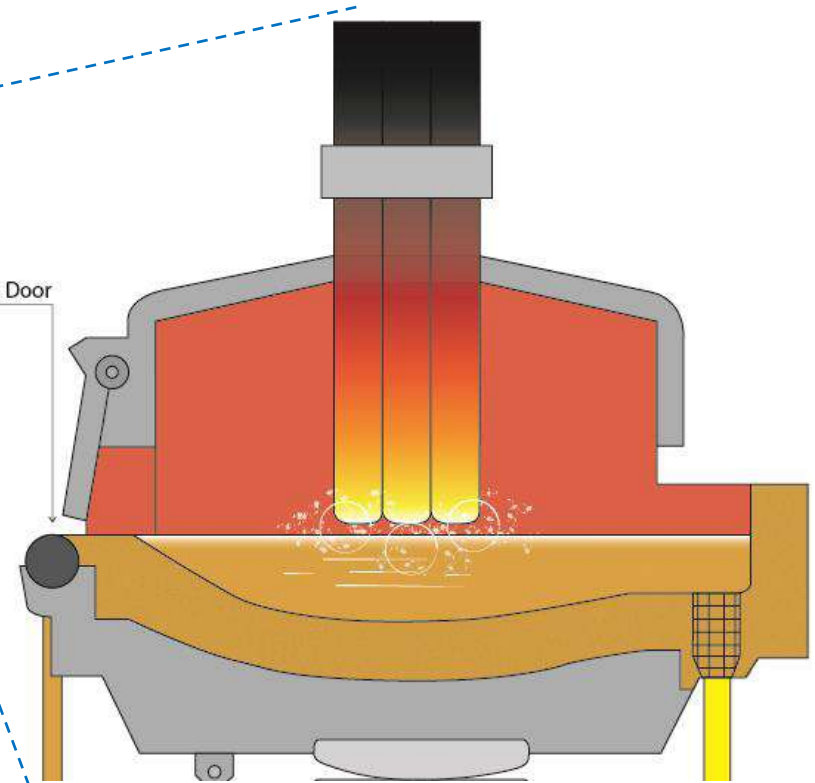

- High Resolution images
- Preset position
- Integration with PLC

INSIDE CONTROL (EAF)

- Three solutions depending of:
distance between door and camera

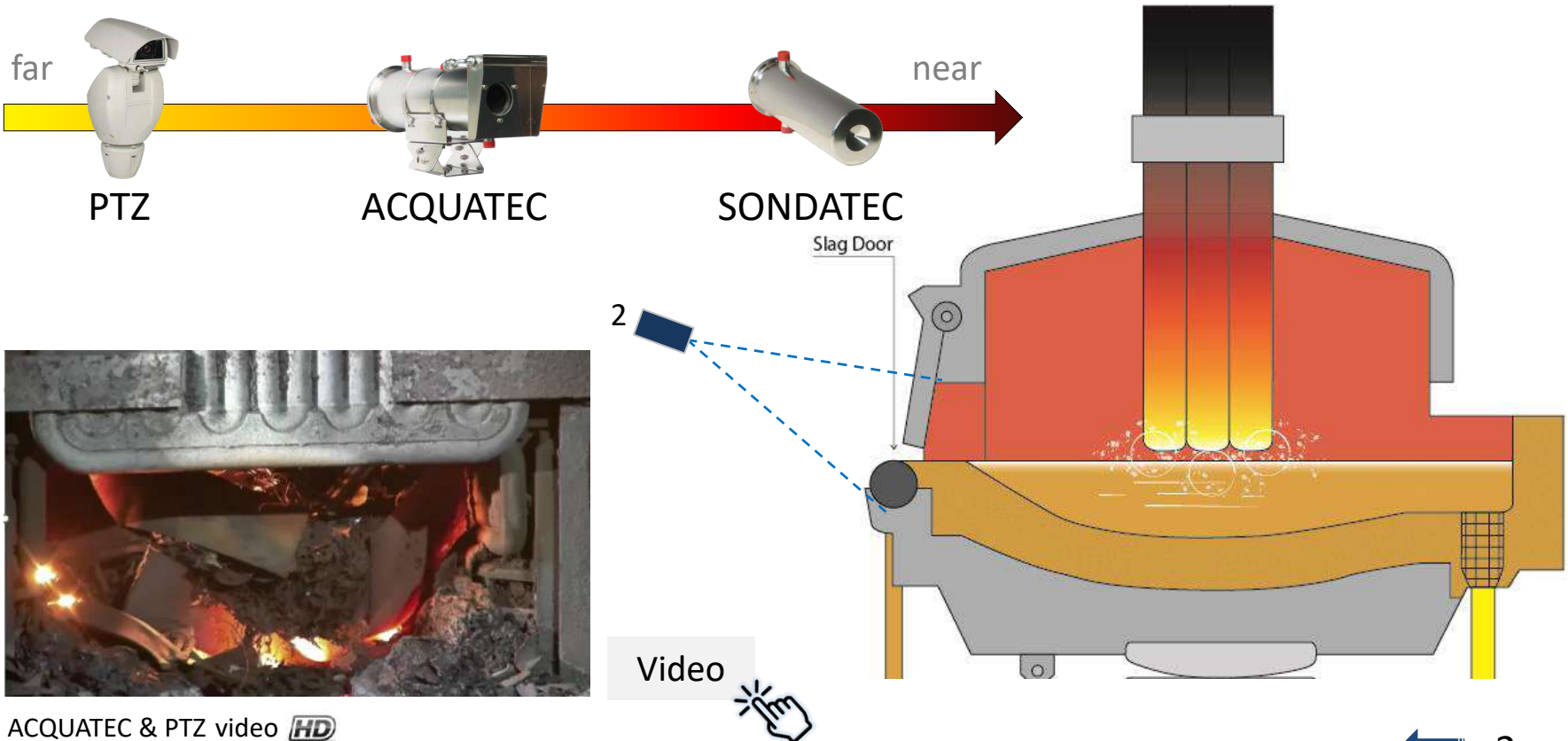

ACQUATEC & PTZ video 

INSIDE CONTROL (EAF)

- Resistant to:
 - High Temperature
 - Steel splash
 - High luminance

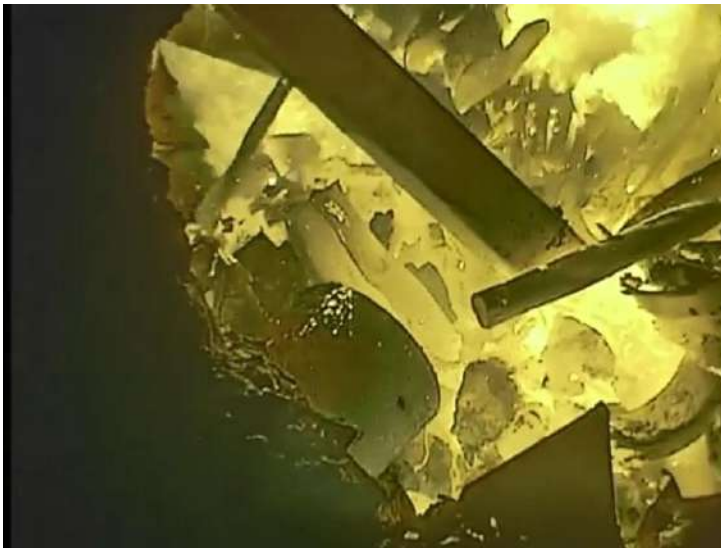
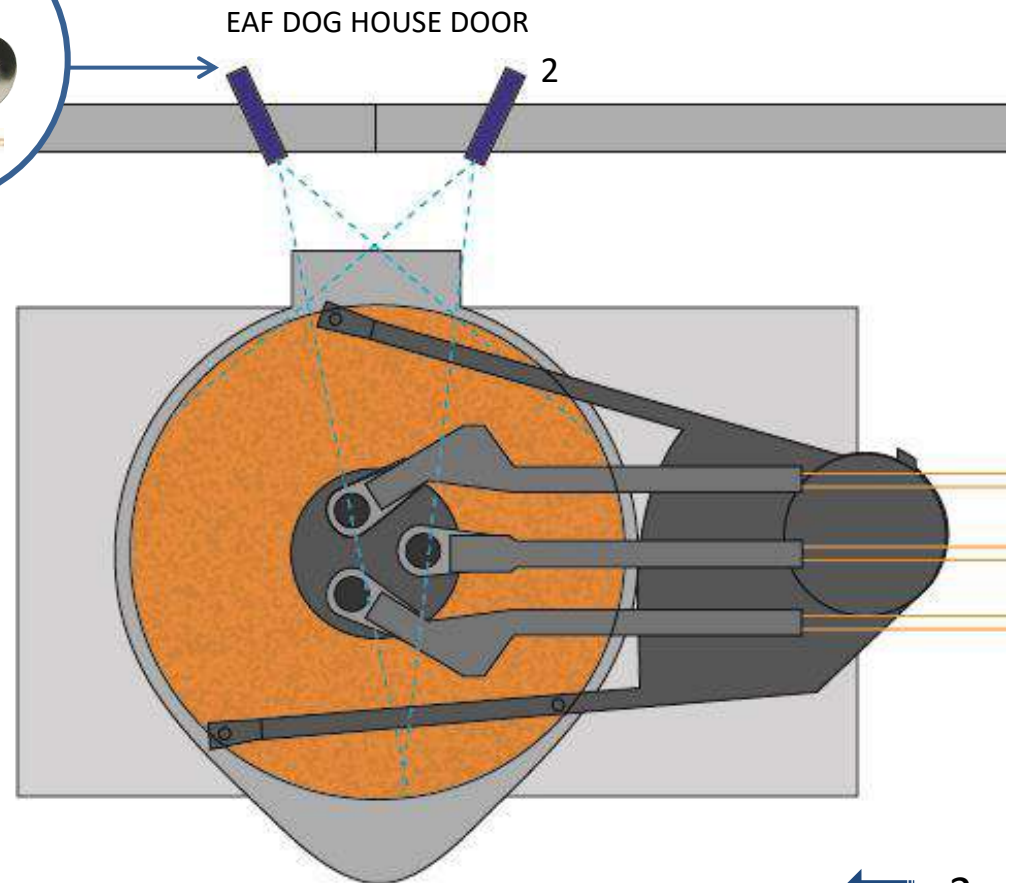

Video



SLAG LADLE VIEW (EAF)

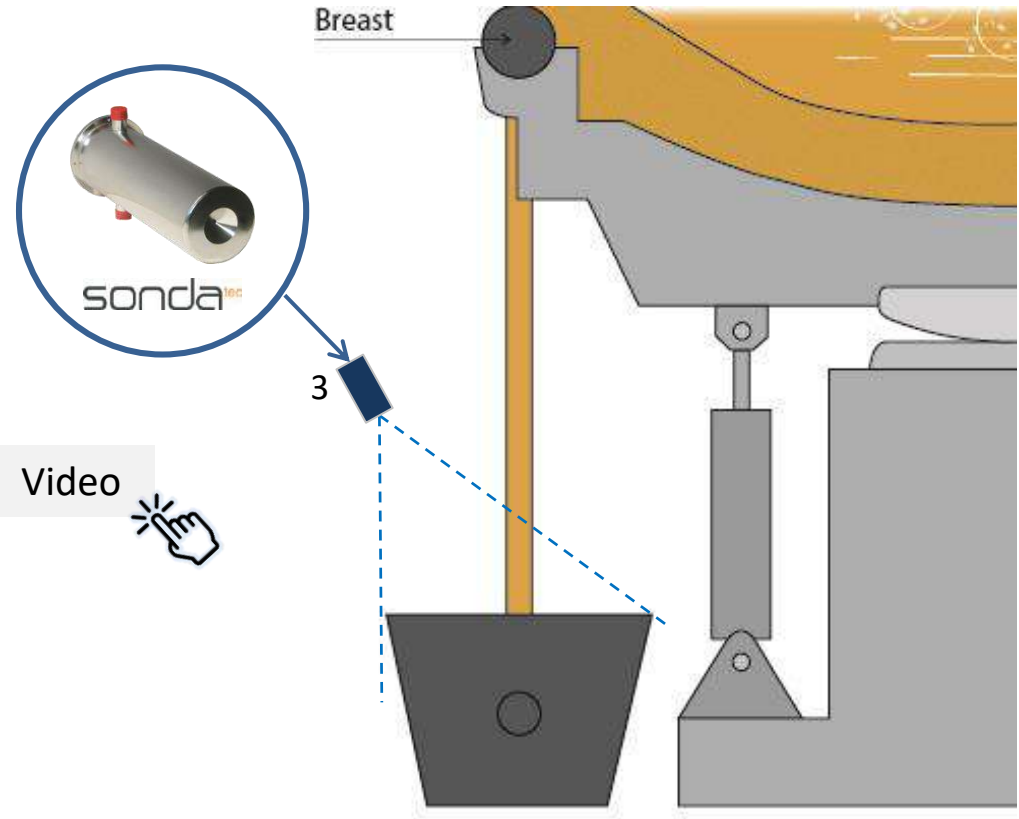

- Resistant to:
 - High temperature
 - Steel splash

COOLED PANELS CONTROL (EAF)

- Special High temperature resistant window
- High Resolution images
- Optical filter

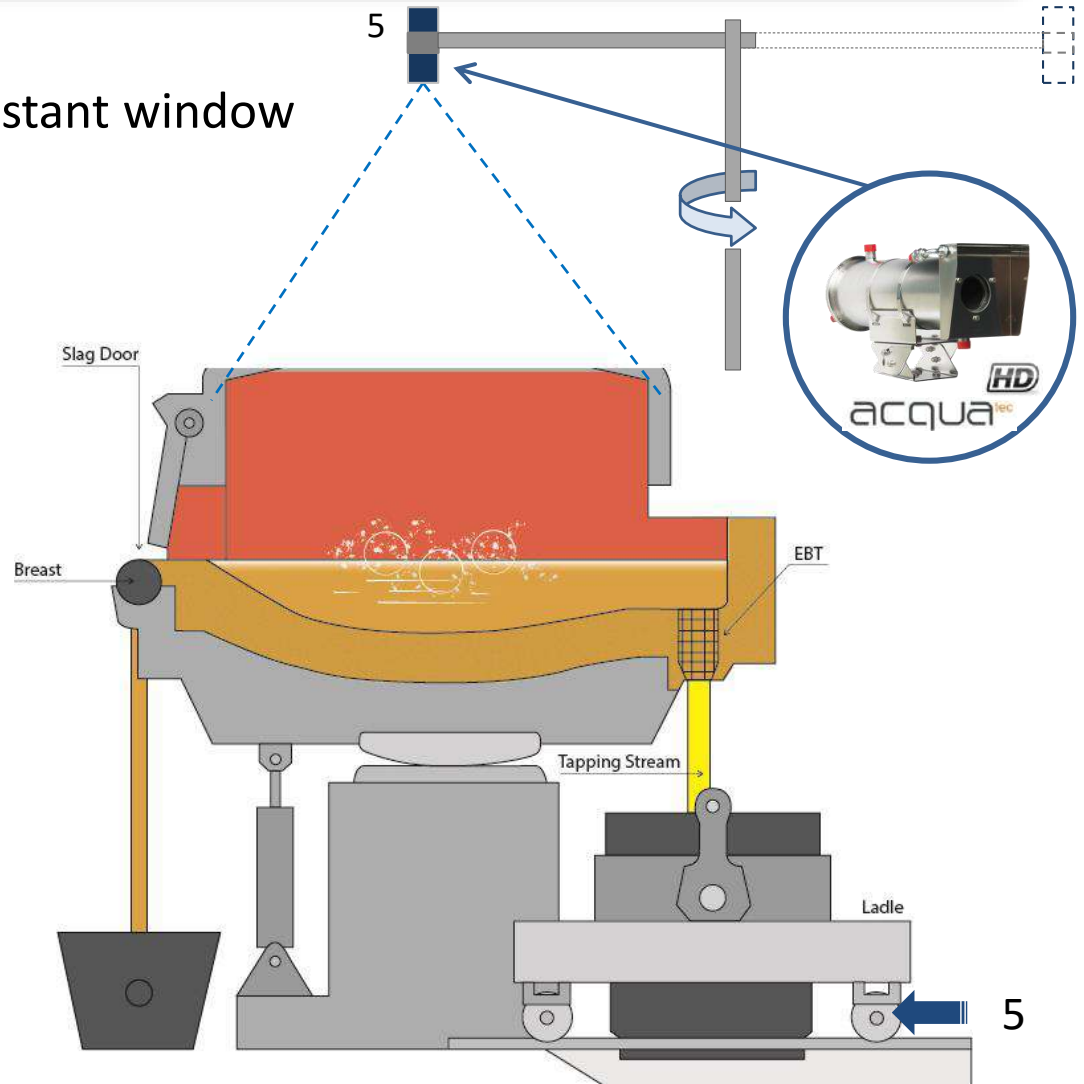
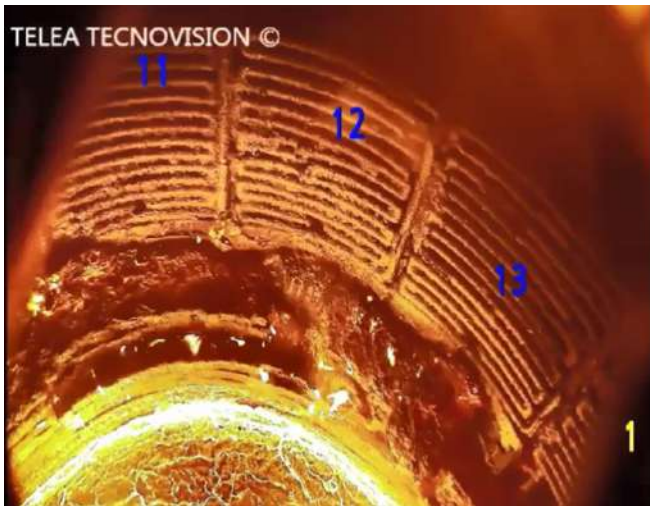

TAPPING (EAF)

- Resistant to:
 - High temperature
 - Electrical interference
 - Dust proof (air purge)

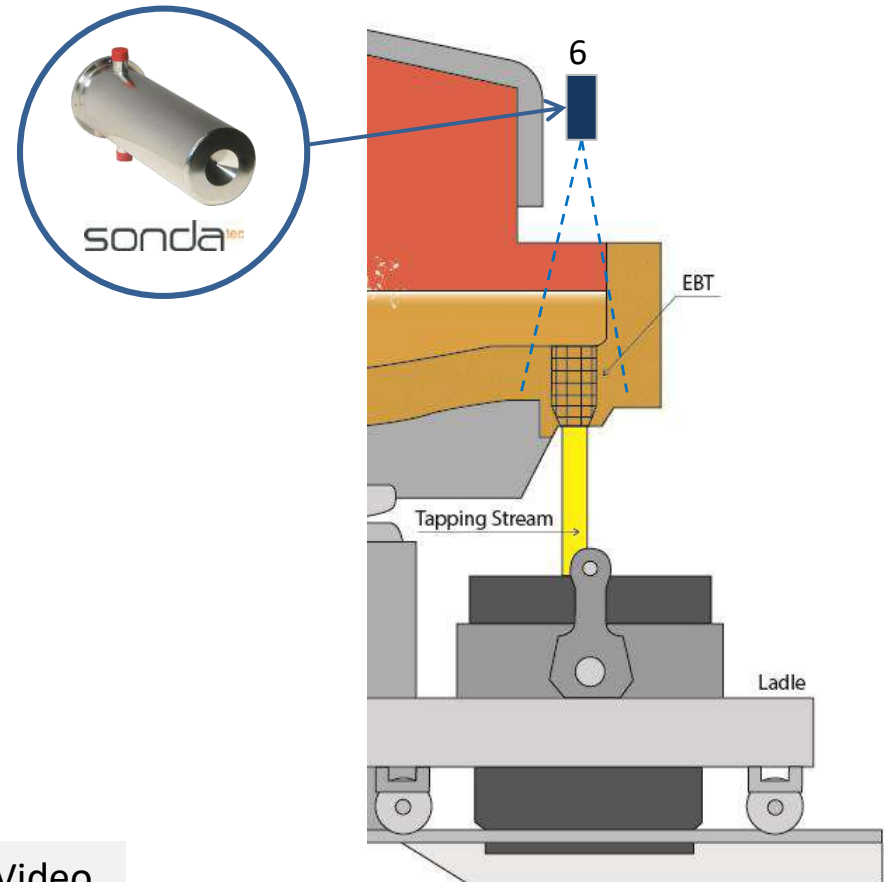
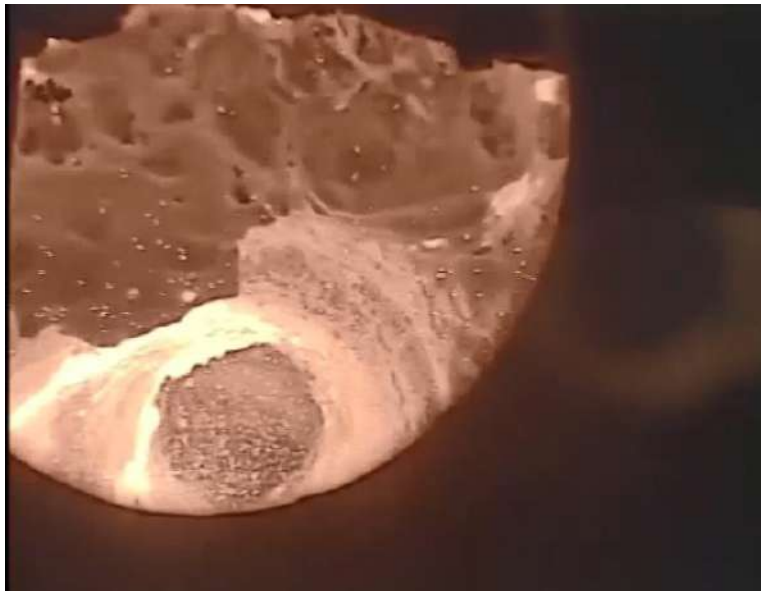

Video



EBT TAPPING (EAF)



- Dust proof with air barrier
- Water cooled (if request)

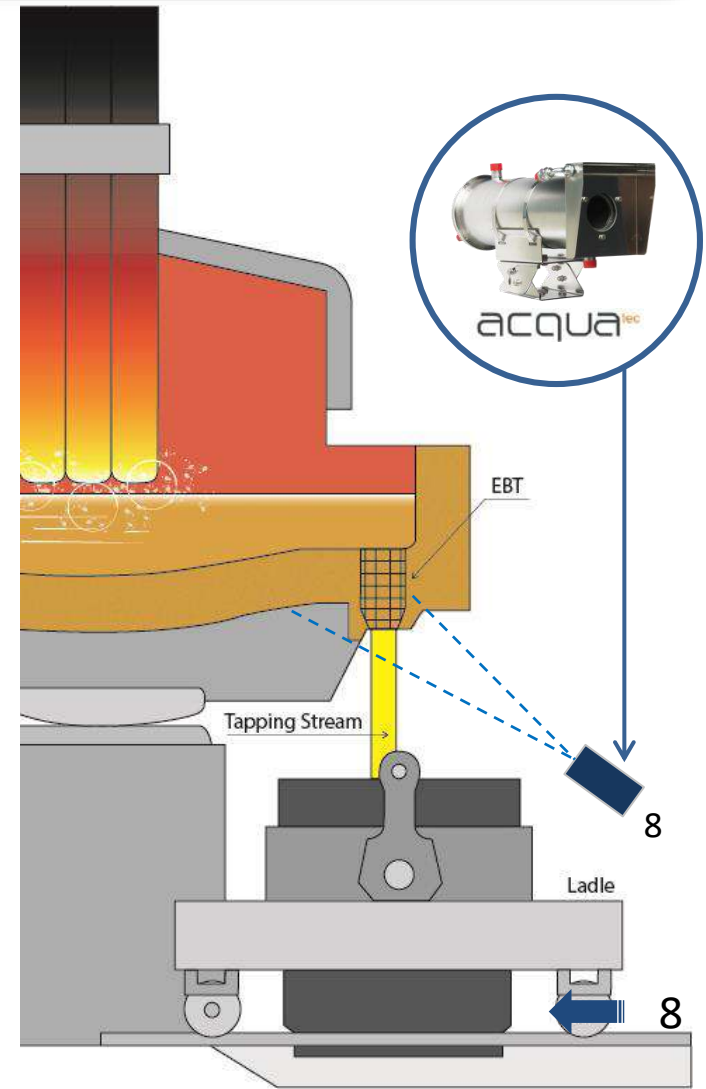

SLAG DETECTION (EAF)



Video



- Housing able to work with Infrared camera
- Germanium or Zinc-Selenium windows
- Resistant to high temperature

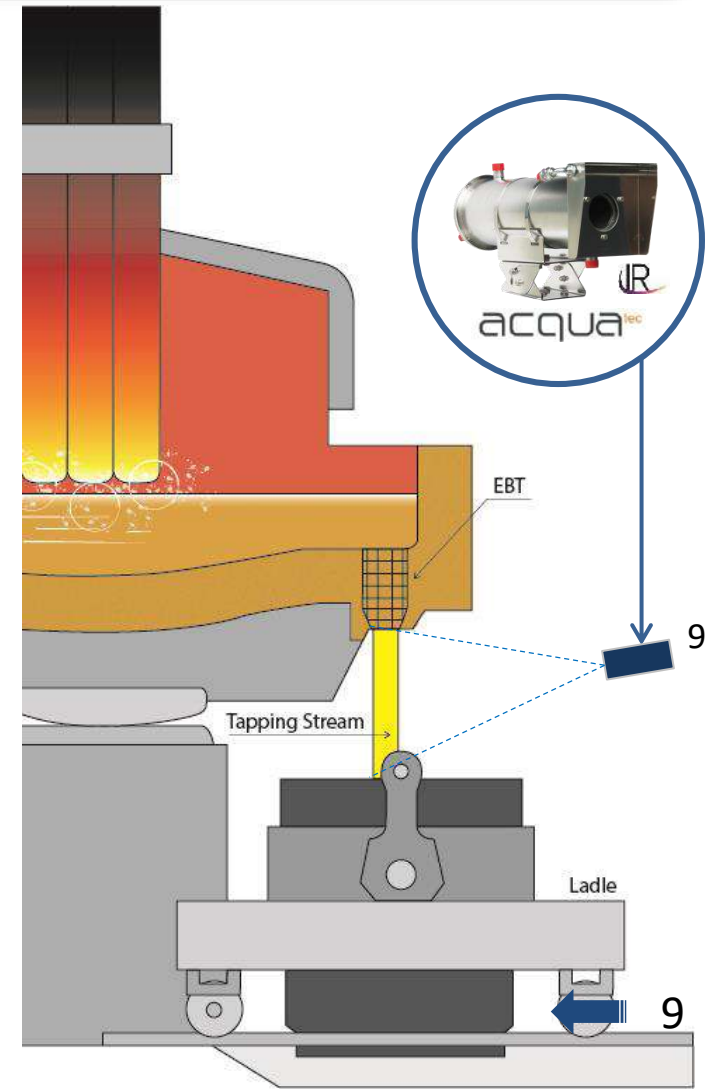

SLAG DETECTION MONITORING SYSTEM (EAF)

Thermal Imaging Camera

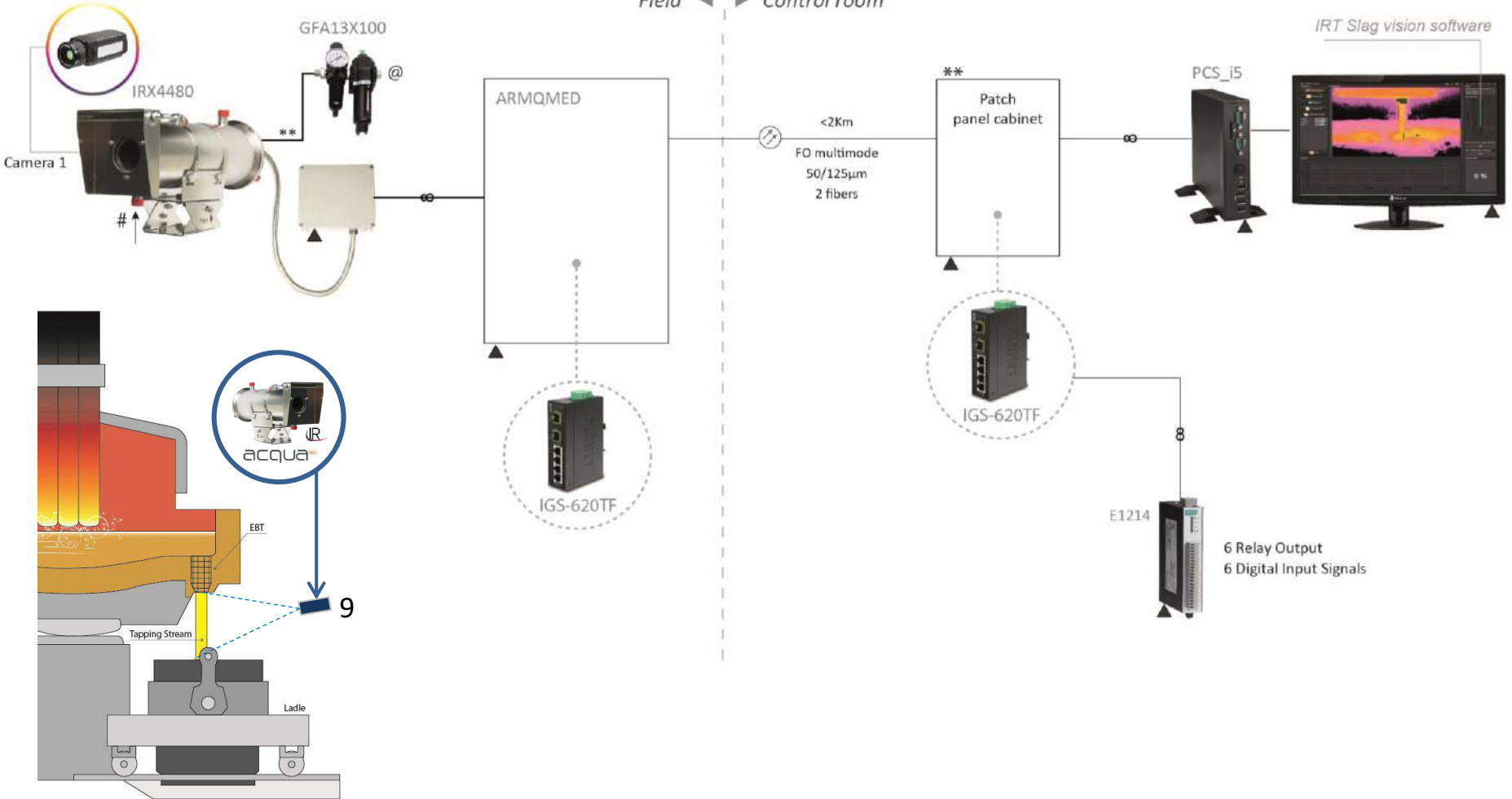

LADLE CAR OVERVIEW (EAF)

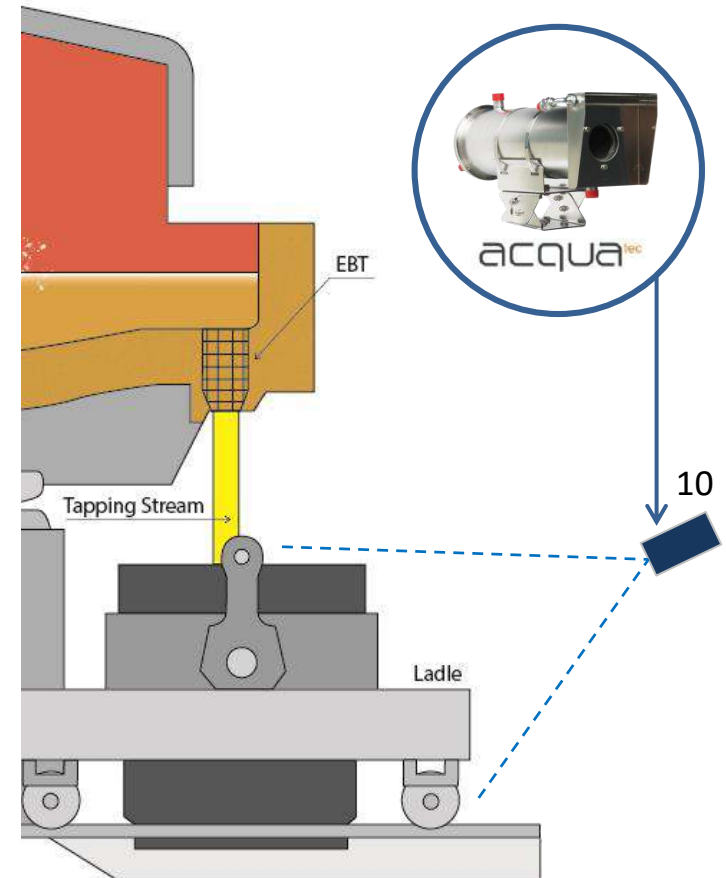

- Dust proof with air barrier
- Water cooled (if request)

LADLE FURNACE (LF) APPLICATIONS

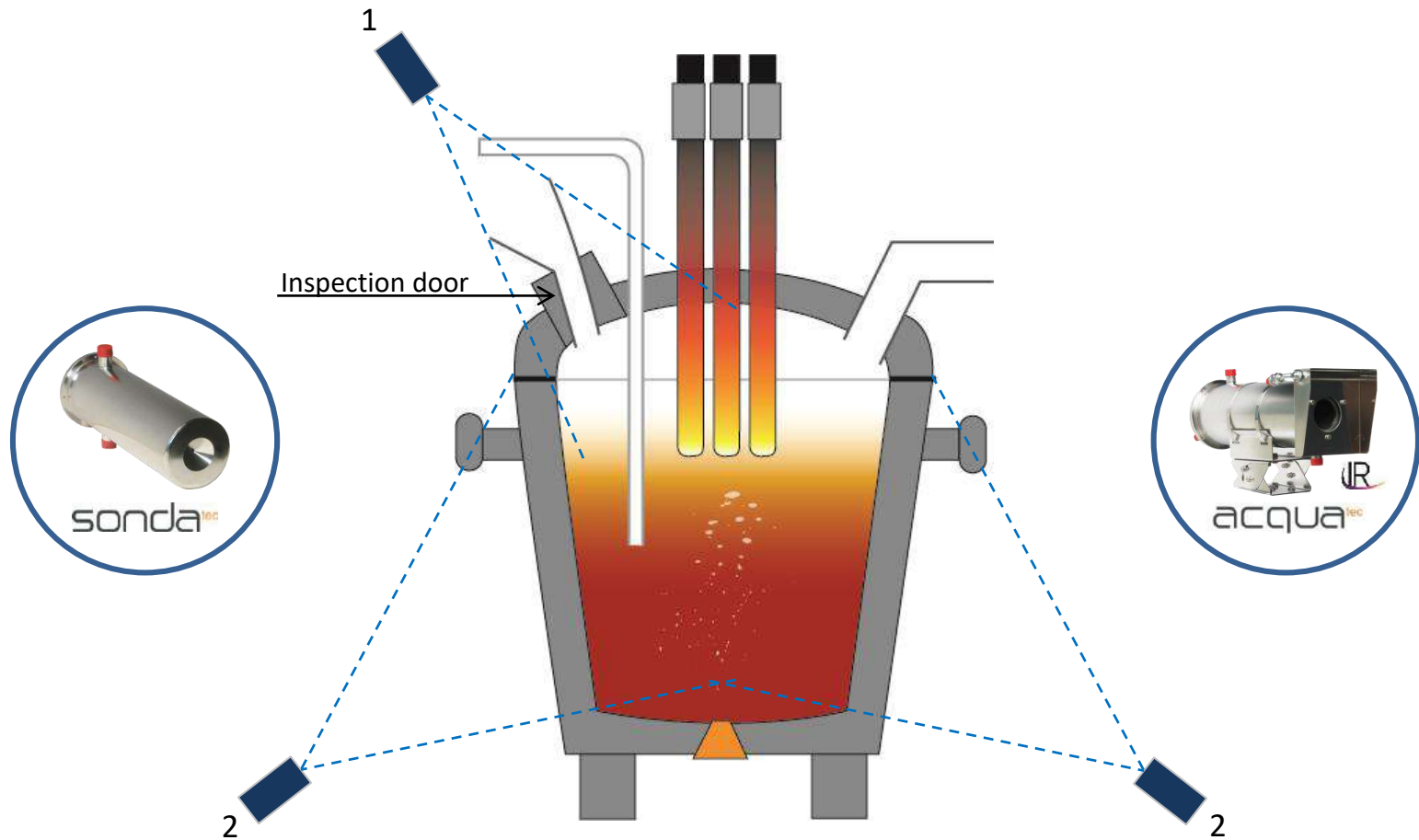

INSPECTION DOOR (LF)



- Resistant to:
 - High temperature
 - Electrical interference
 - High Lights

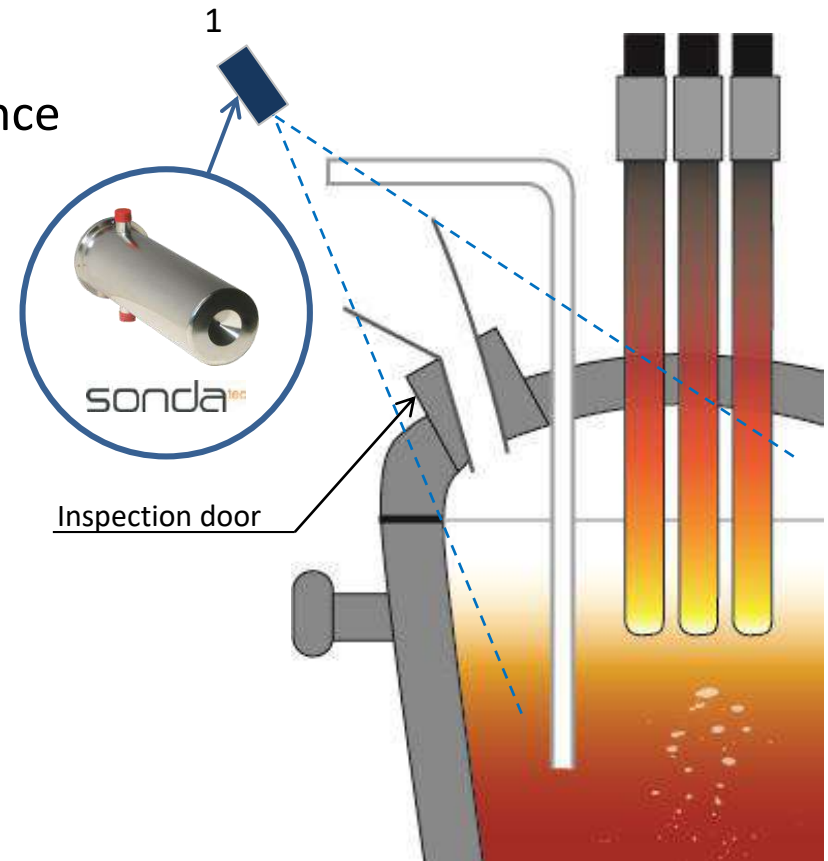

MILL LADLE REFRACTORY MONITORING (LF)

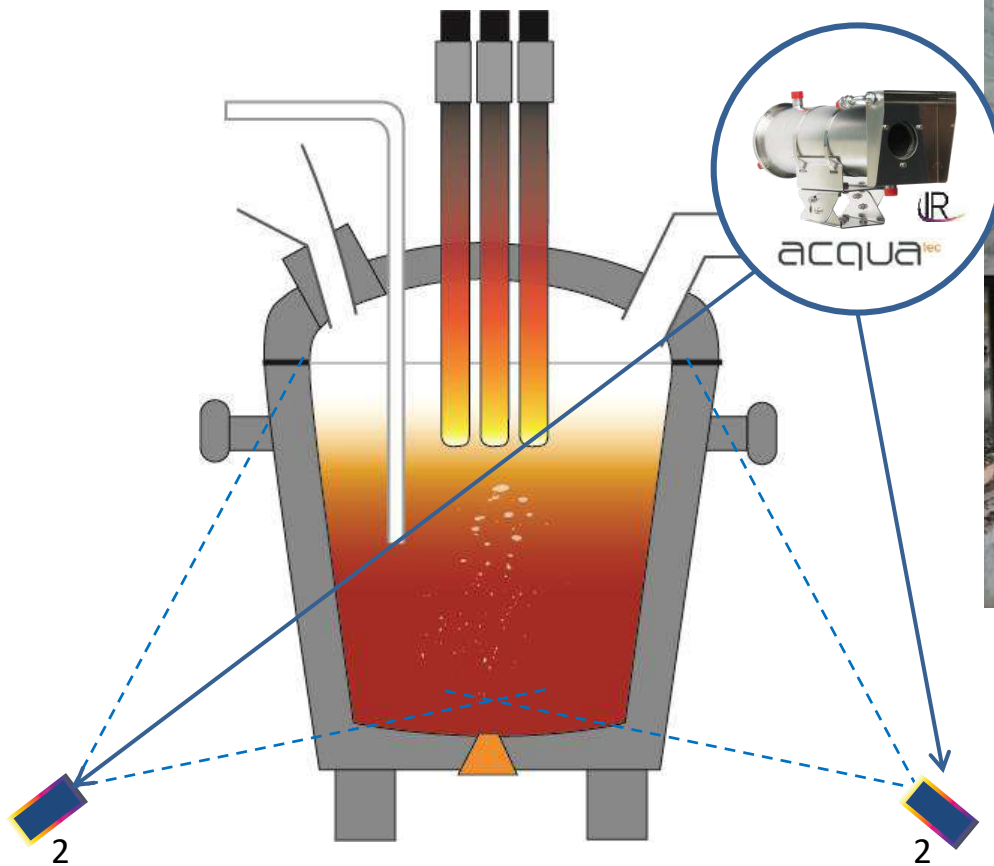

- Integrated IR cameras with Acquatec housings
- Germanium or Zinc-Selenium Windows
- Resistant to High temperature

MILL LADLE REFRACTORY MONITORING (LF)

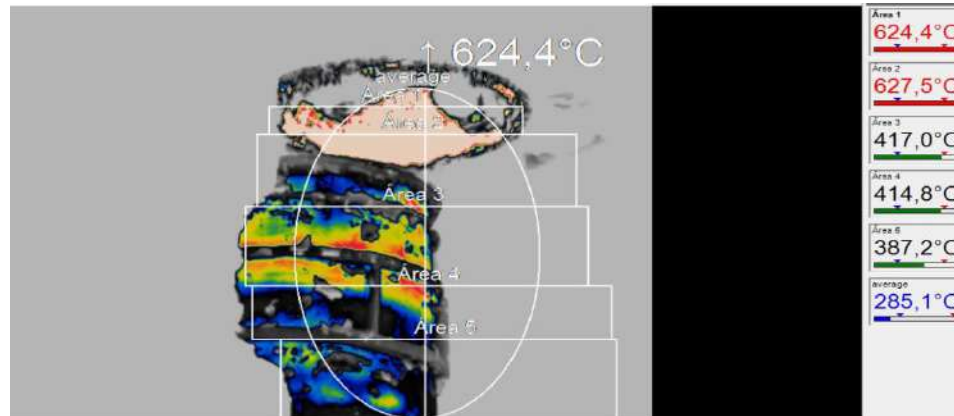
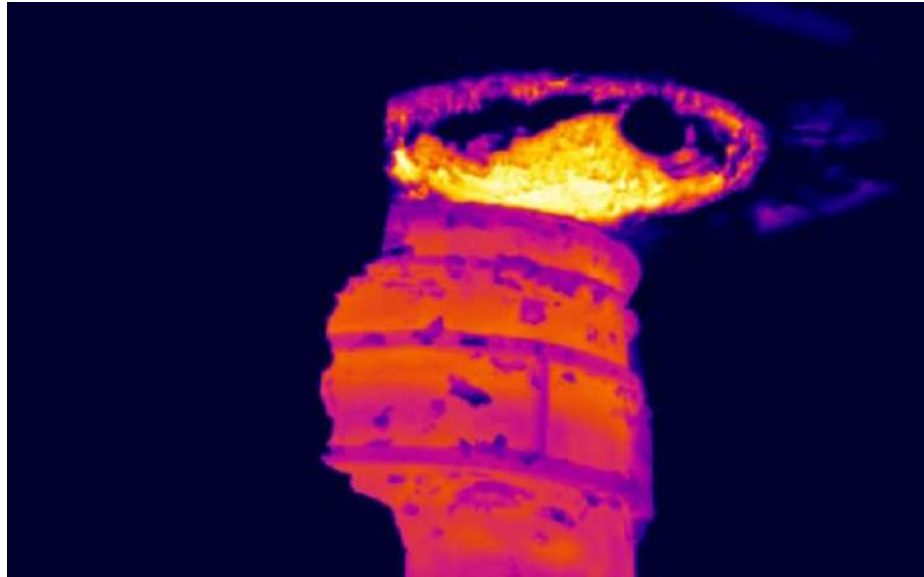

MILL LADLE REFRACTORY MONITORING (LF)

Thermal Imaging Camera



Thermal Imaging Camera



Up to 5 Thermal imaging cameras

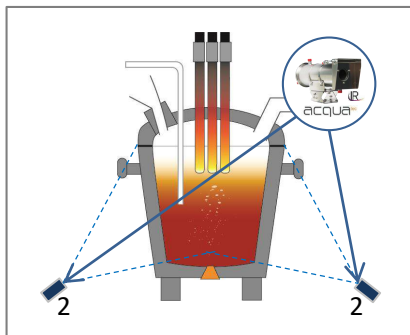

Field ◀ ▶ Control room

EXAMPLE OF APPLICATION

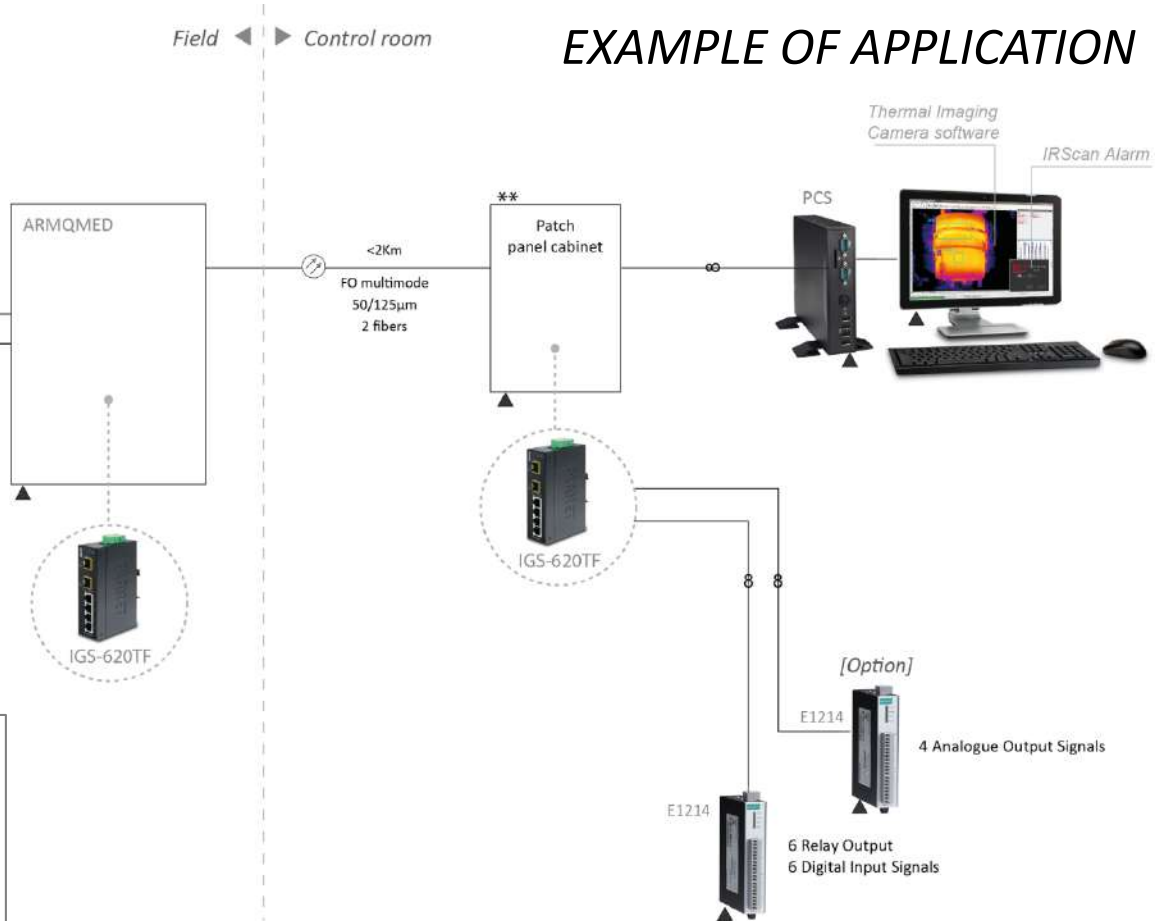

VACUUM DEGASSING (VD) APPLICATIONS

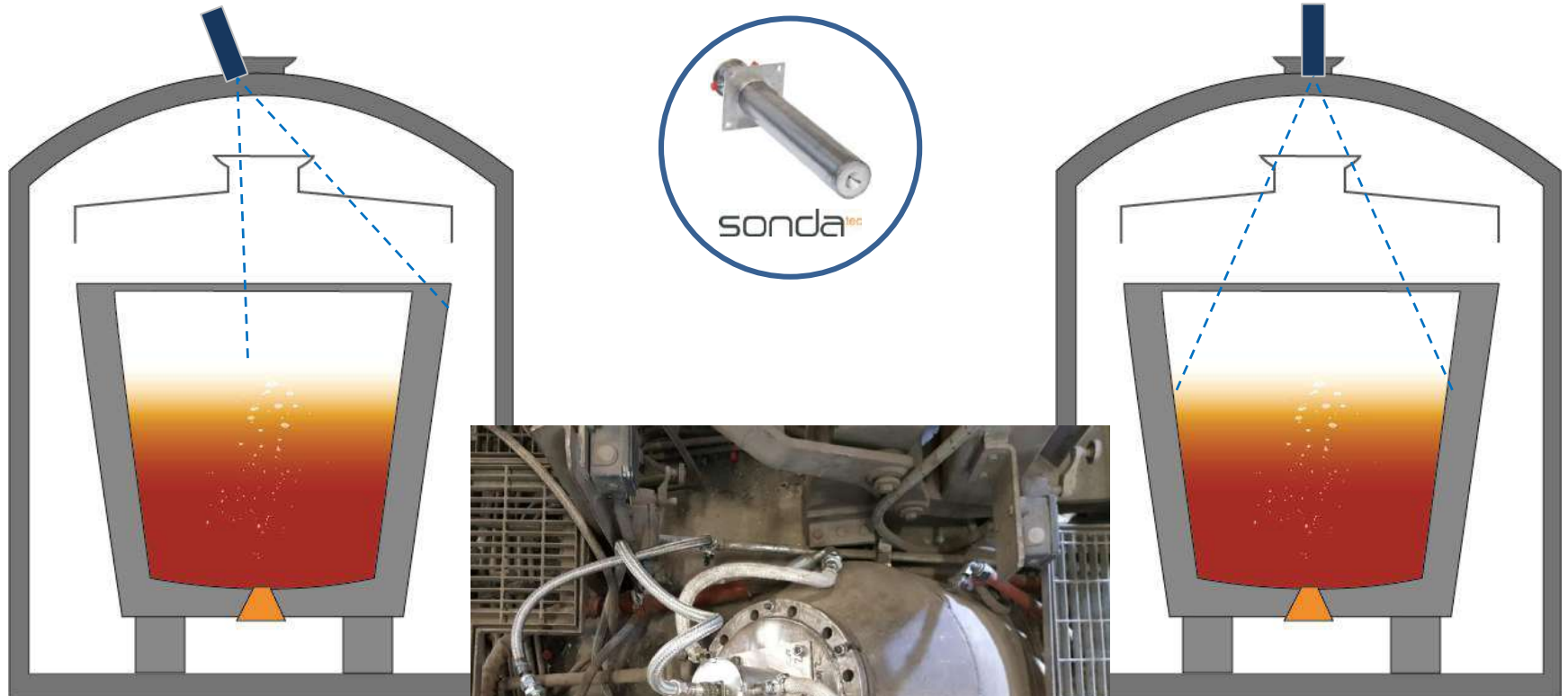

VACUUM DEGASSING (VD) APPLICATIONS

- Resistant to:
 - High temperature
 - Steel splash
 - High luminance



- Low Nitrogen consumption
- Fast recovery



Video



LADLE HOLE MONITORING

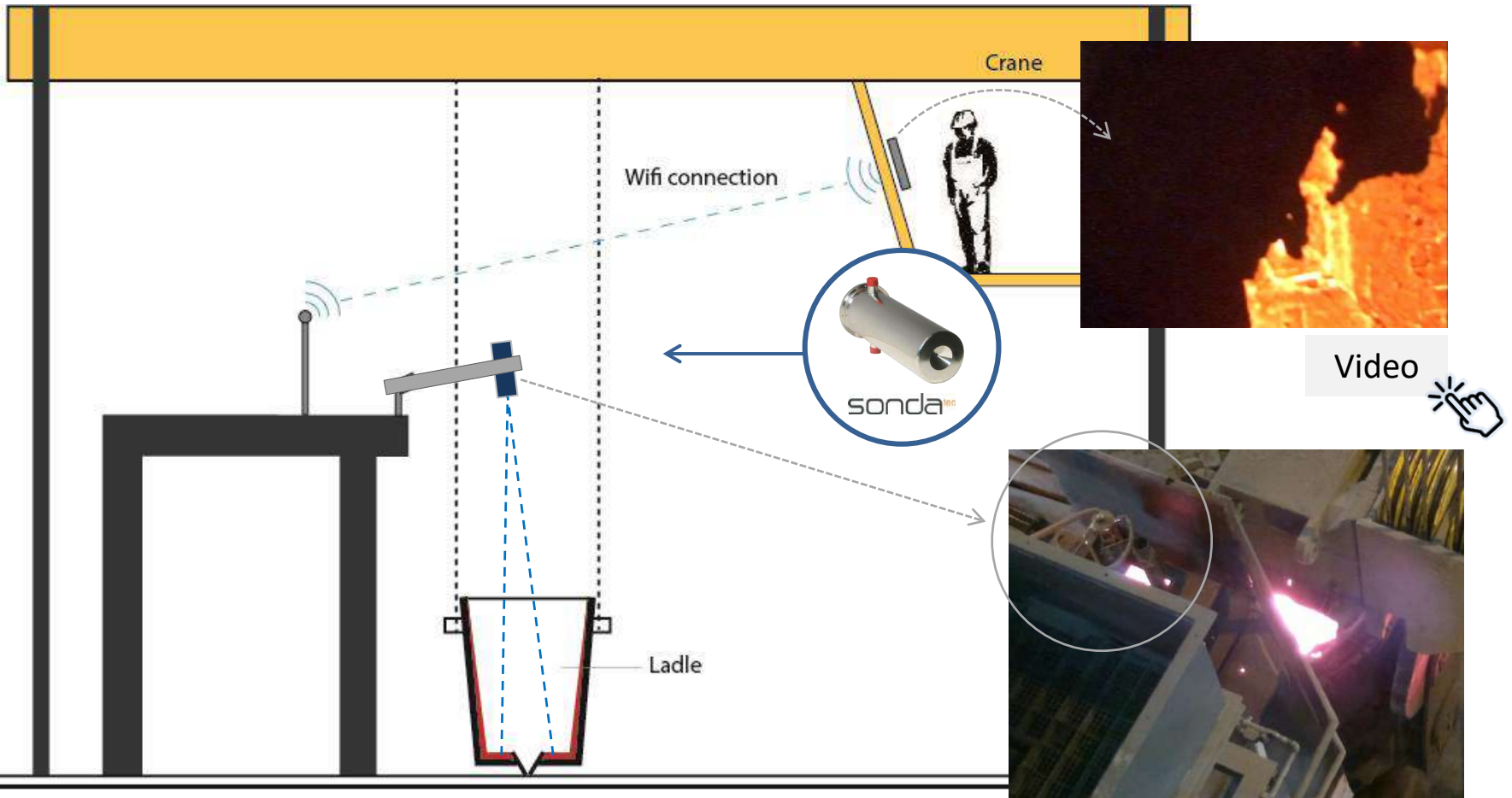

CONTINUOUS CASTING MACHINES (CCM) APPLICATIONS

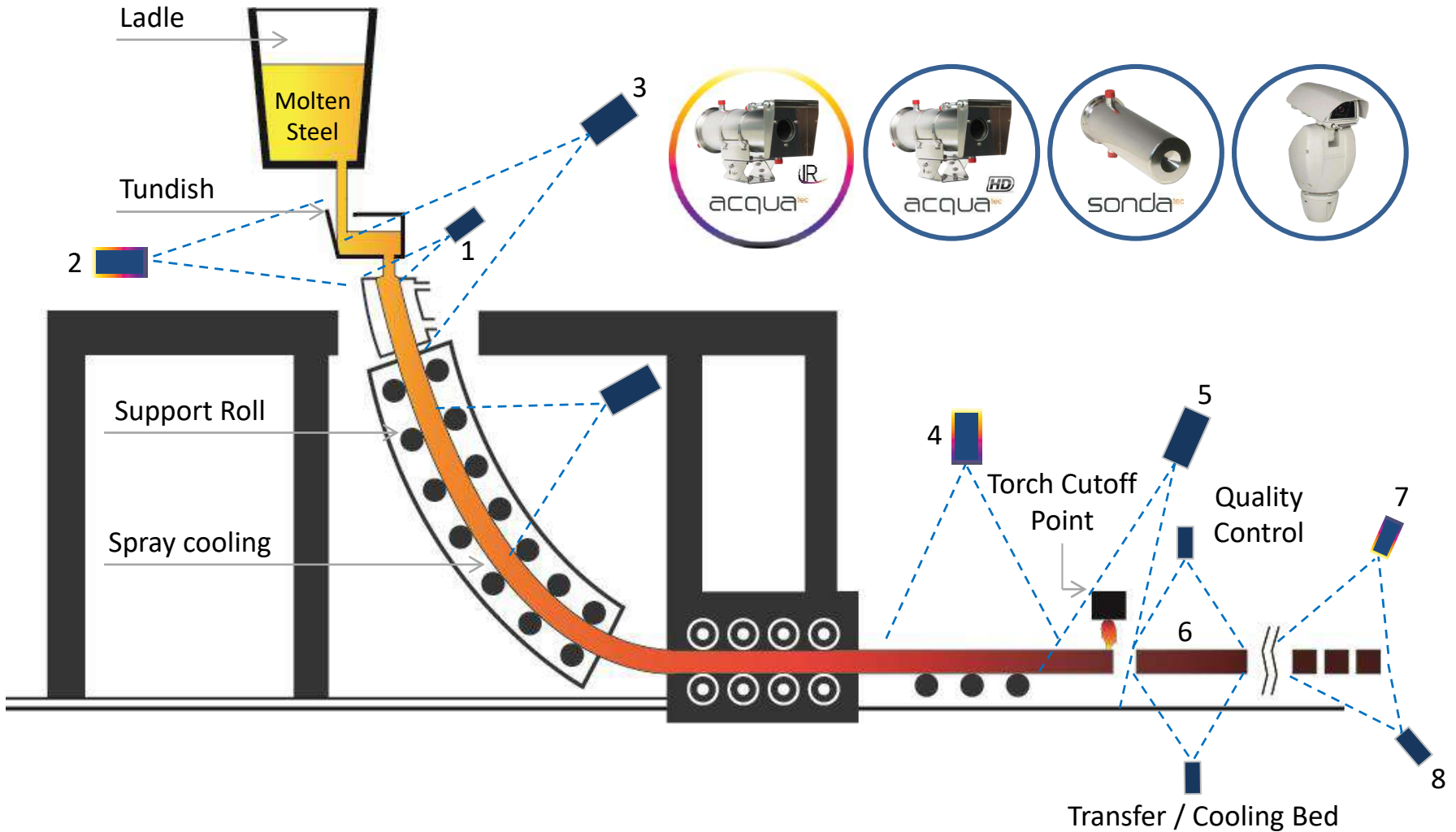

SUBMERGED ENTRY NOZZLE MONITORING (CCM)

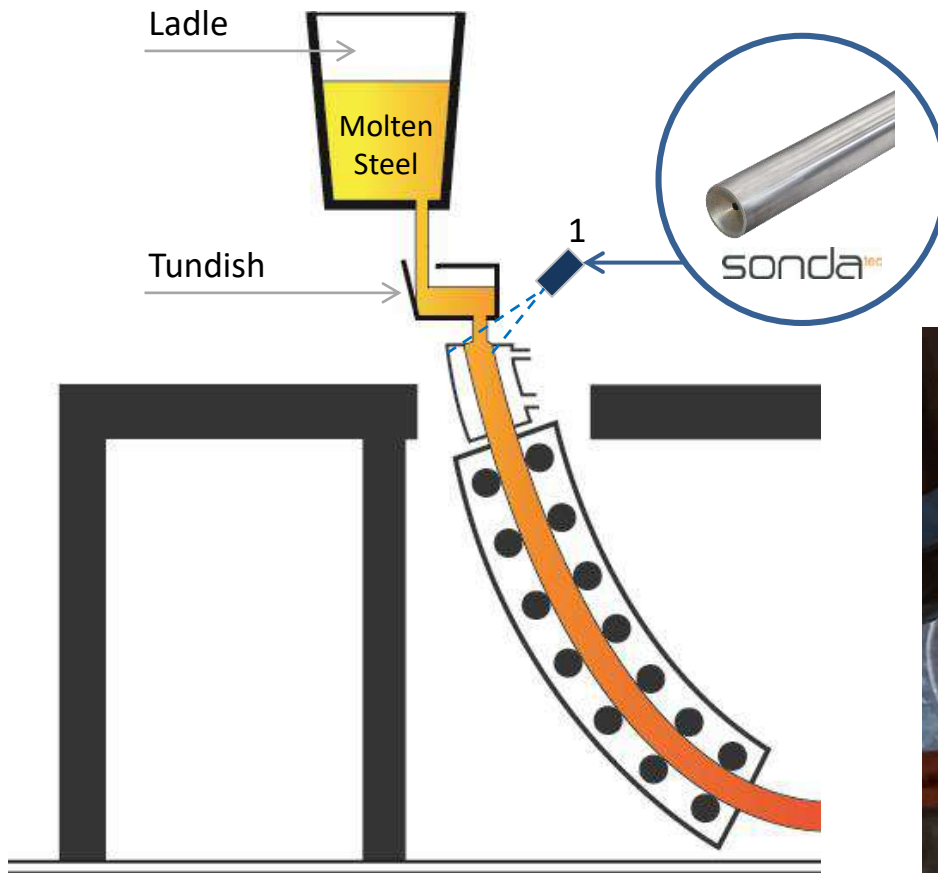

- High Resolution
- Dust proof (air purge)
- Compact design



Video



TUNDISH AREA MONITORING (CCM)

Metal pots carrying melted metal to dies in continuous casting called tundishes, are facing extreme hot materials inside. Surface temperature control is necessary to avoid any risks. Especially in the back side of tundishes, where the highest temperature values are exist.

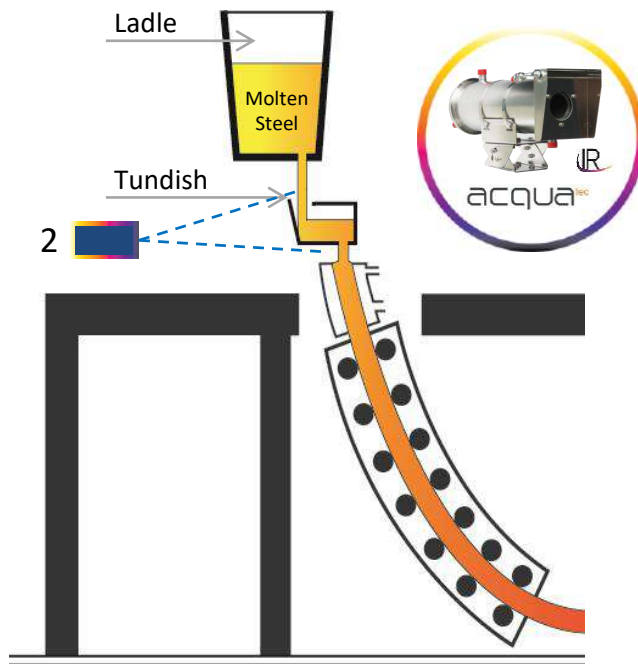

TUNDISH AREA MONITORING (CCM)

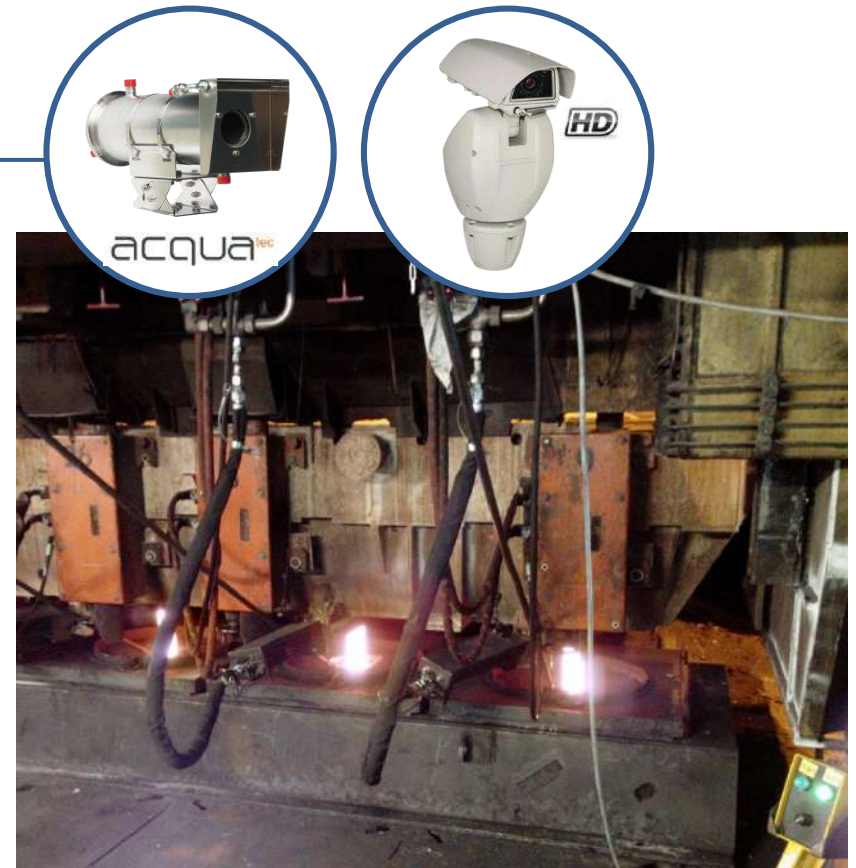
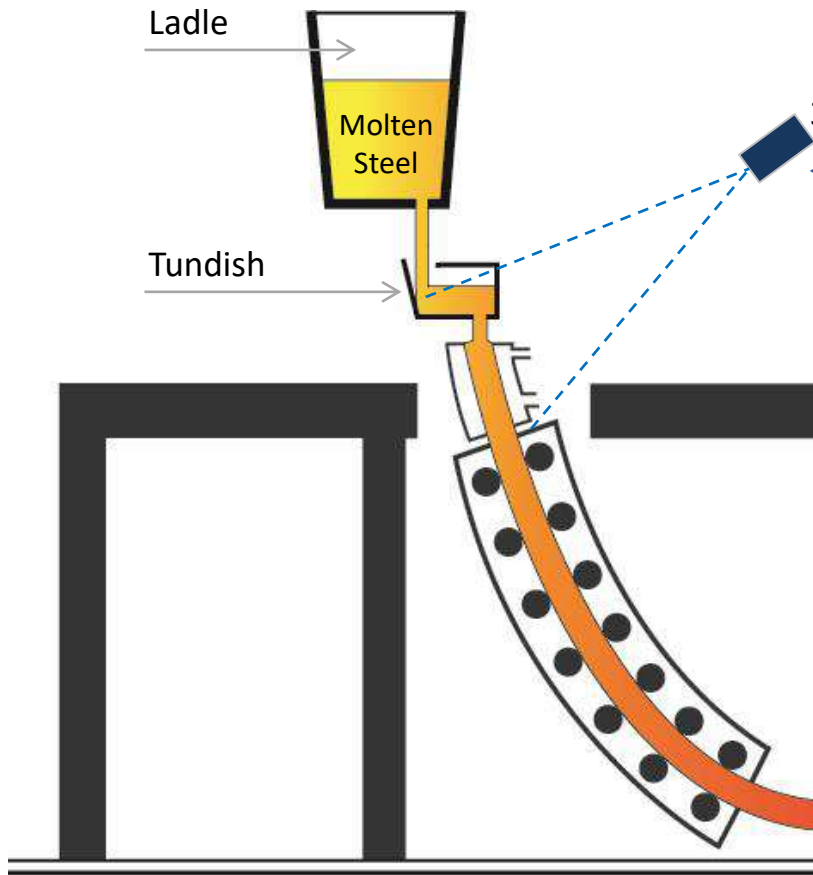

DISCHARGING AREA (CCM)

Product temperature measurement in discharge of continuous casting. Temperature detecting before cutting process is important for a high quality of slab and problem detecting in following processes. Datas receiving from pirometers in this area also can be used as hot metal detector.

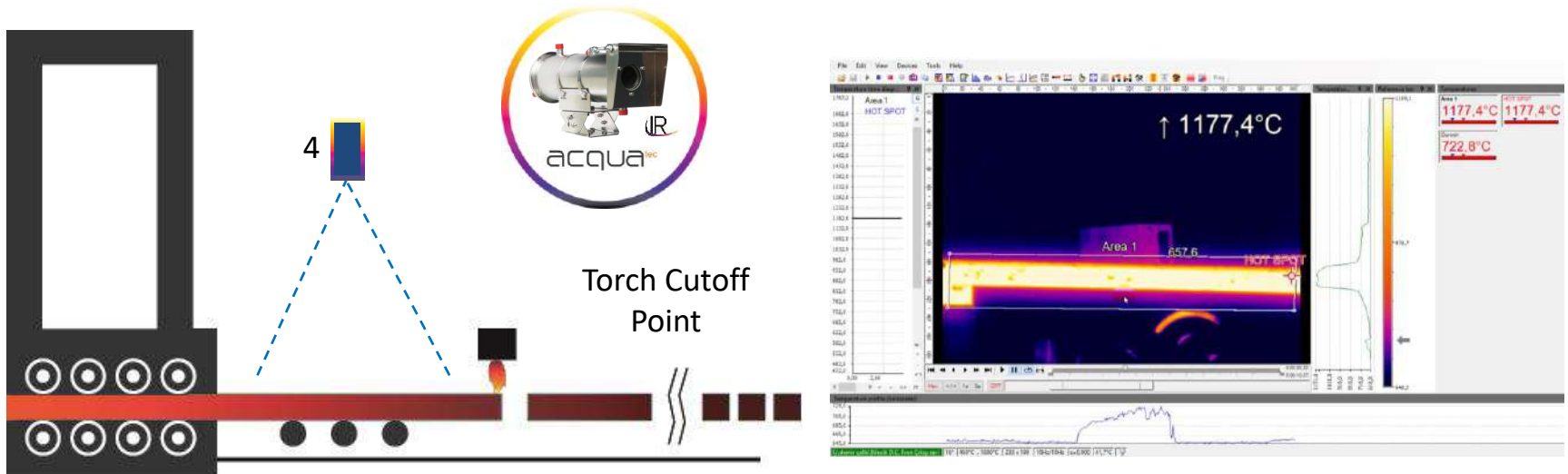

CUTTING PHASE (CCM)

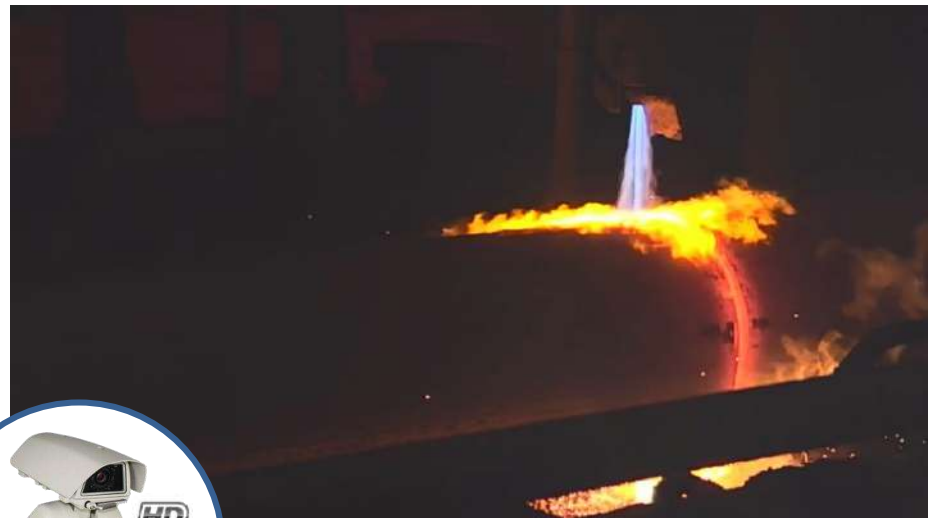

Video

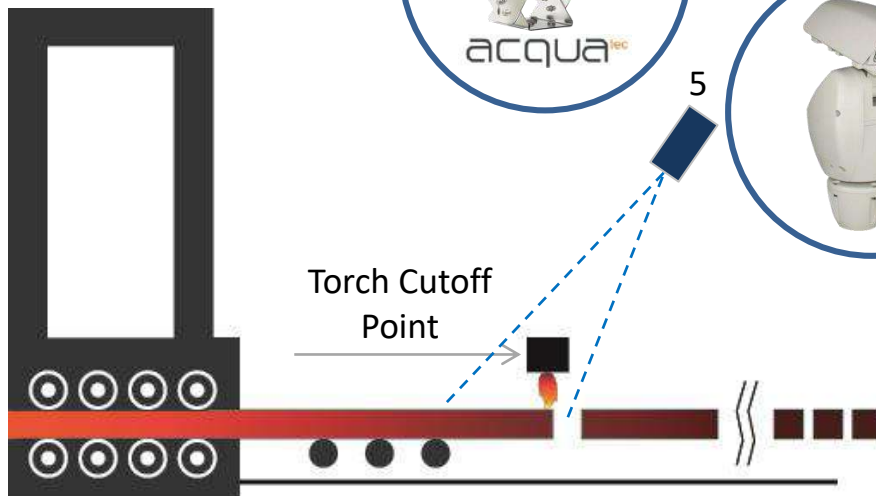

- High Resolution images
- Luminosity multi-preset control
- Integration with automation
- Zoom HD camera

AFTER CUTTING PHASE (CCM)

Temperature measurement of all discharge lines continuous casting with one thermal camera. All temperature data are being received simultaneously at once.

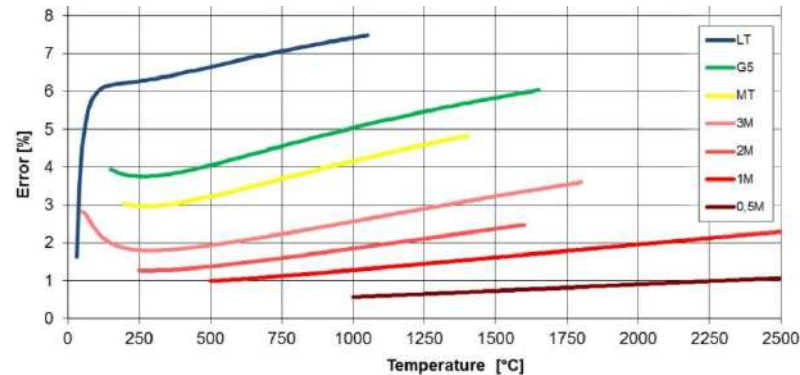
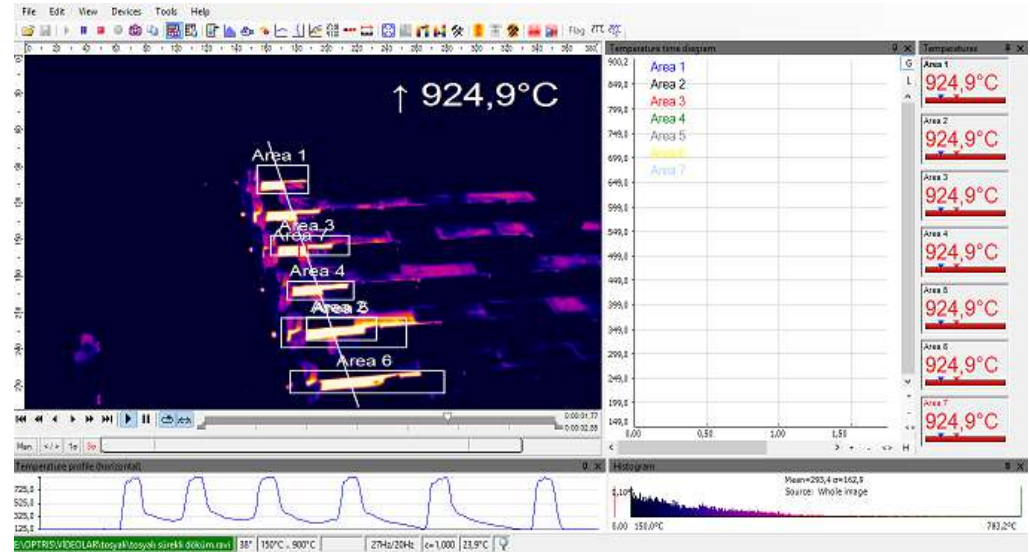

Optional output signals for online process automation are also served for applications.

QUALITY CONTROL (CCM)

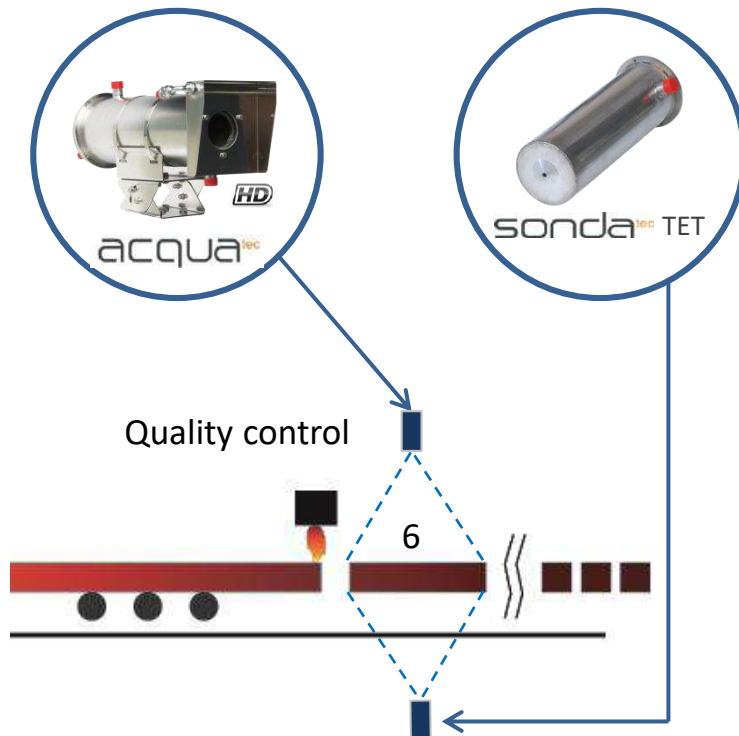

Video



- High Resolution Image
- Water splash resistant

CONTINUOUS CASTING (CCM)

Cooling scales of products coming from cutting process can be analysed by thermal cameras in line. Datas are being saved as thermal or normal images.

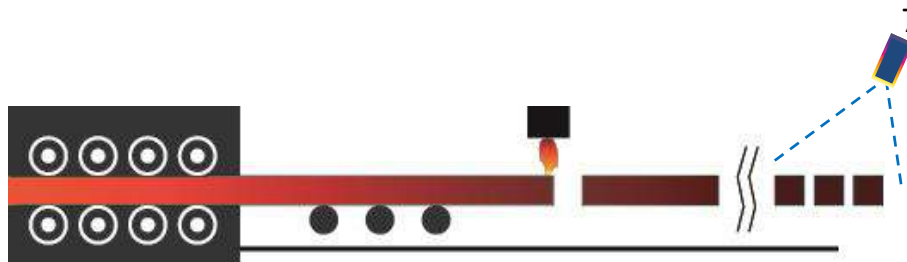
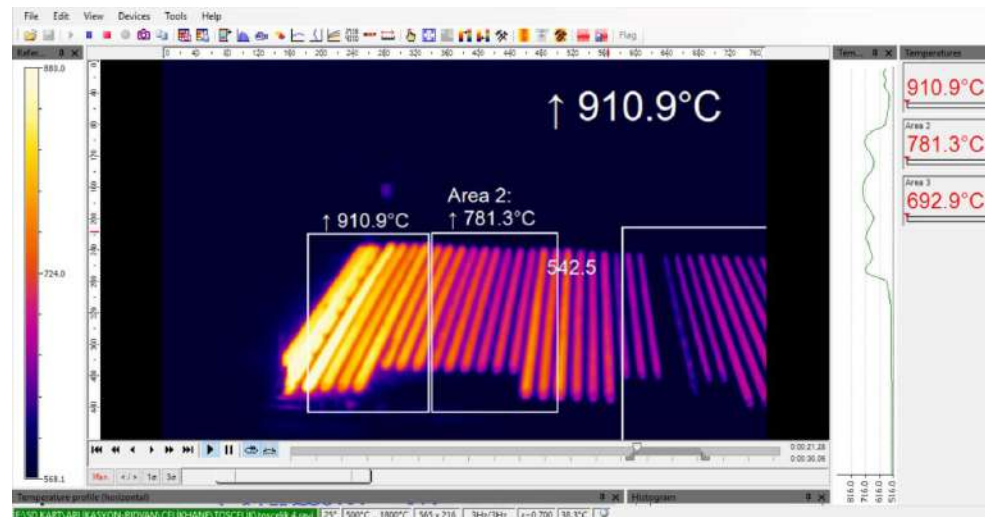

CONTINUOUS CASTING (CCM)

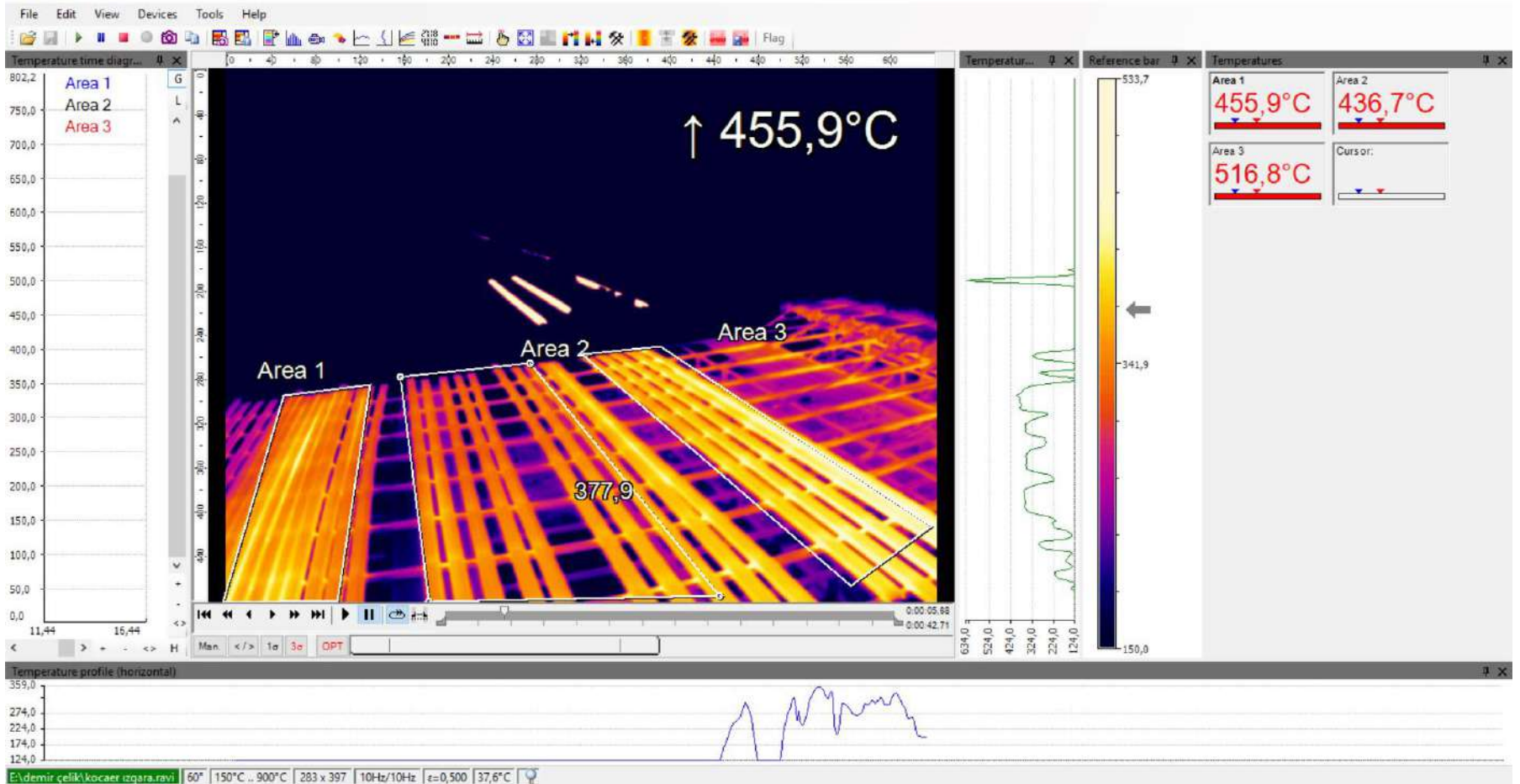

TRANSFER / COOLING BED (CCM)



Video 

- High Resolution Images
 - Preset Position
 - Controlled by Automation
- Transfer / Cooling Bed

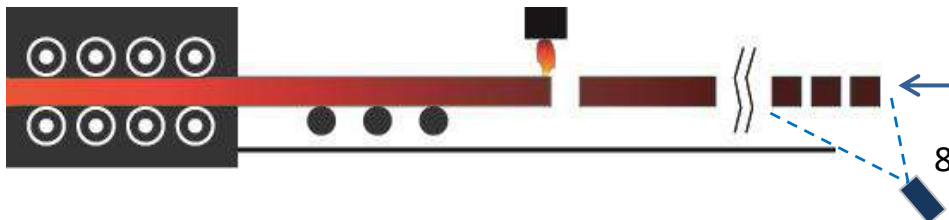

SOLUTIONS FOR THERMAL IMAGING CAMERA APPLICATIONS

EXAMPLE of BASIC SYSTEM CONFIGURATION

IRScan® Alarm

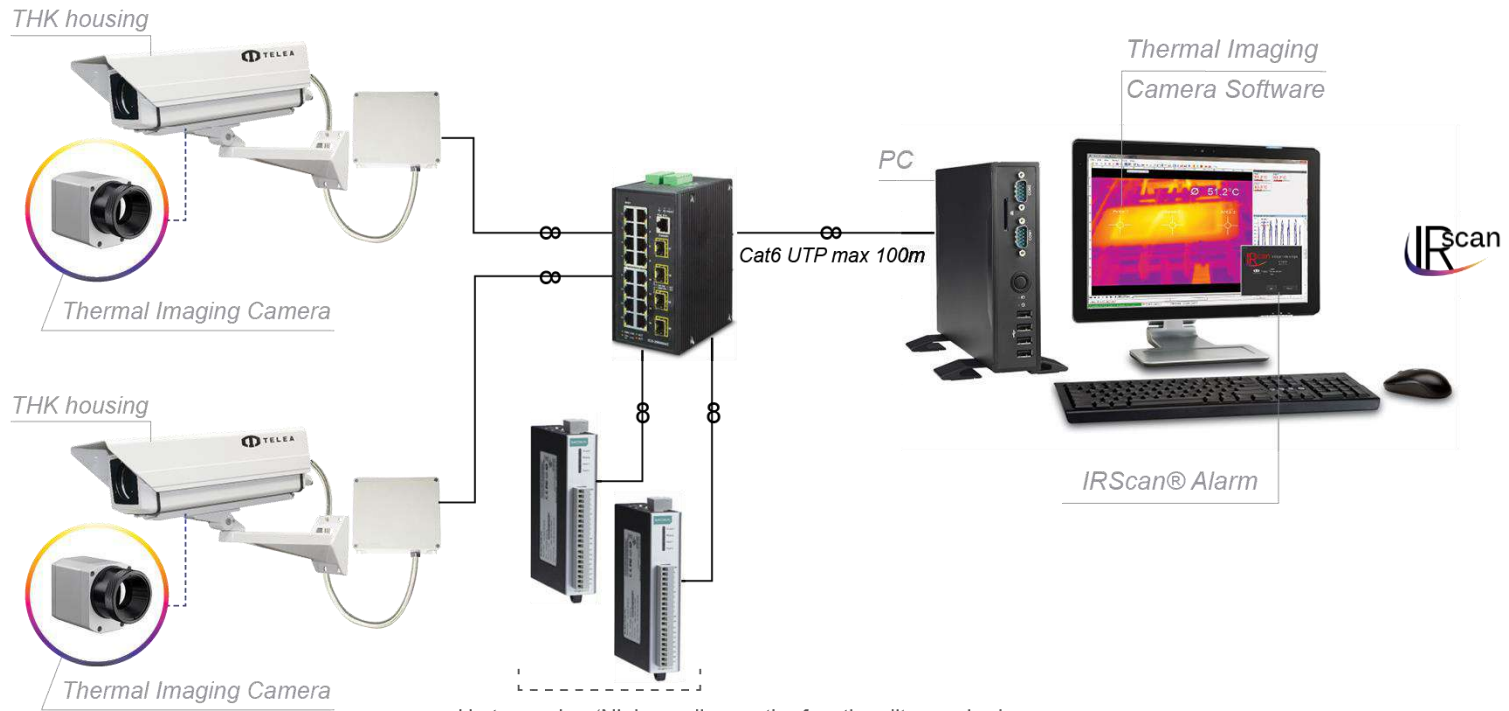

Up to number 'N' depending on the functionality required

ROLLING MILL RE-HEATING FURNACE (RHF) APPLICATIONS

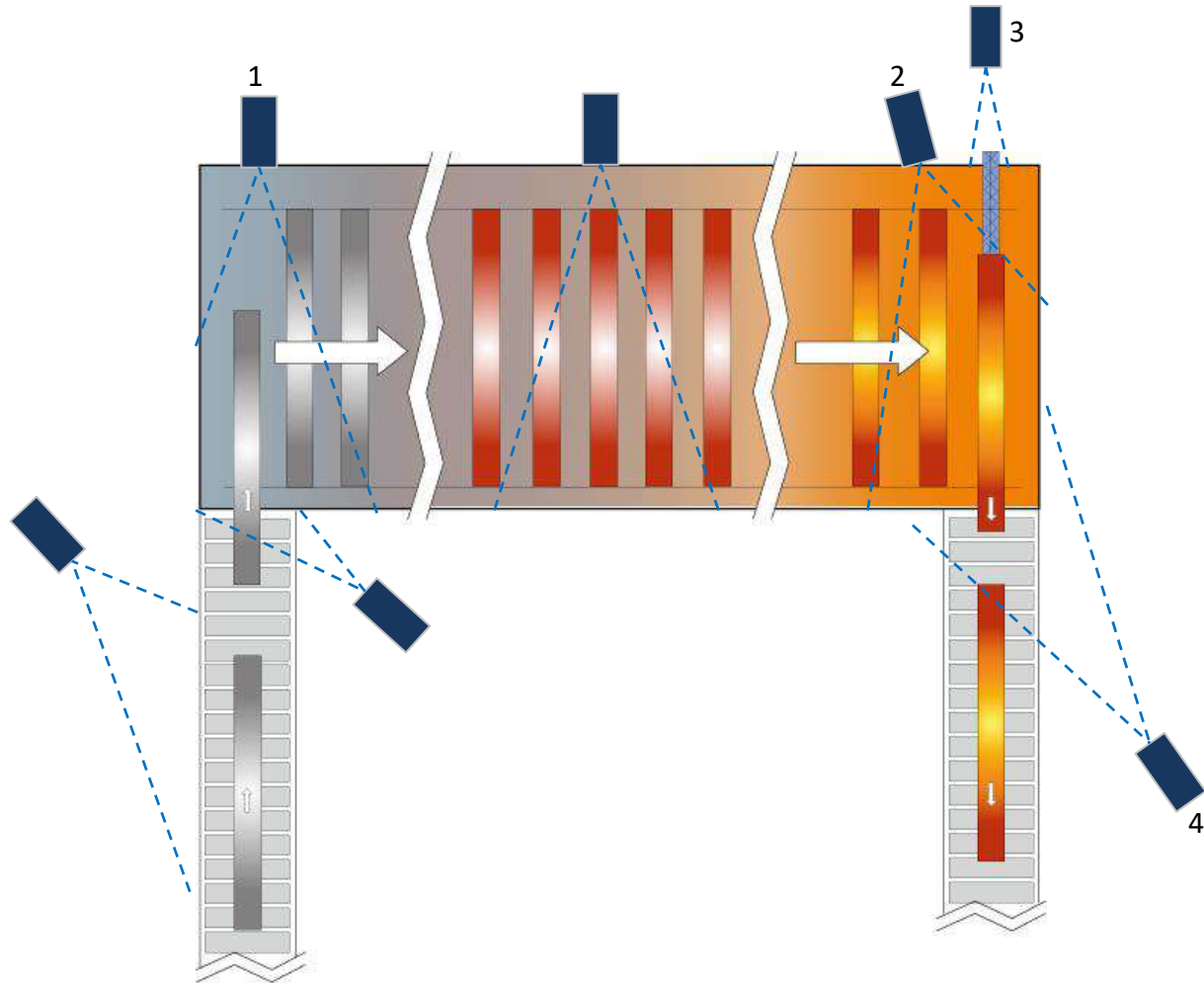

CHARGING & DISCHARGING INSIDE VIEW (RHF)

- Three possible solutions:



Charging
inside view

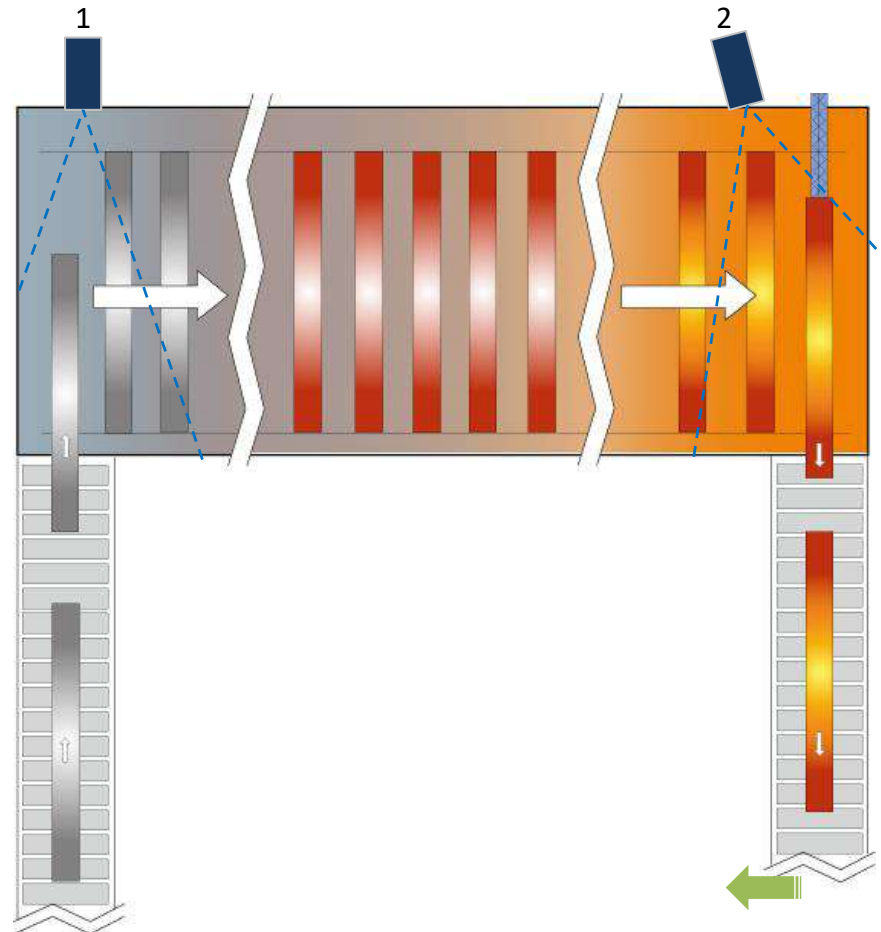

CHARGING INSIDE VIEW (RHF)



- Low light level required

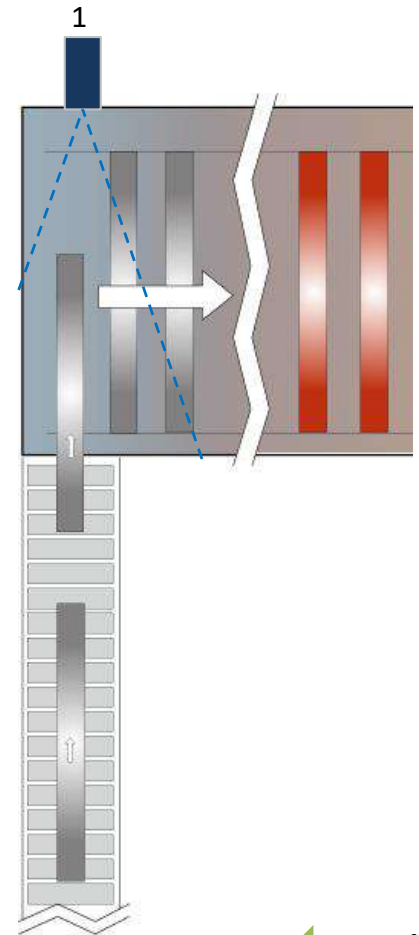

DISCHARGING INSIDE VIEW (RHF)

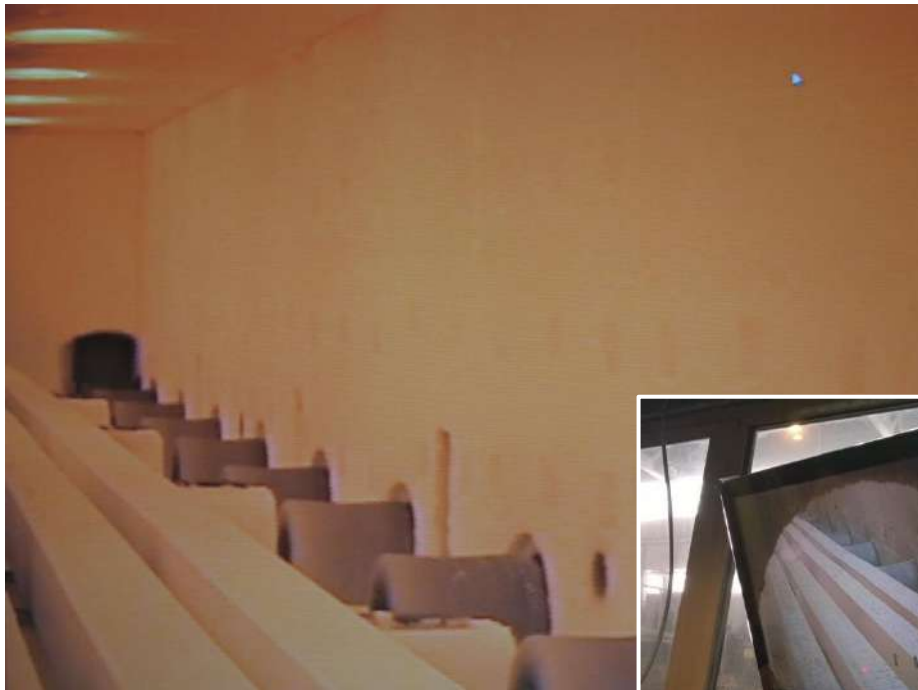

Video

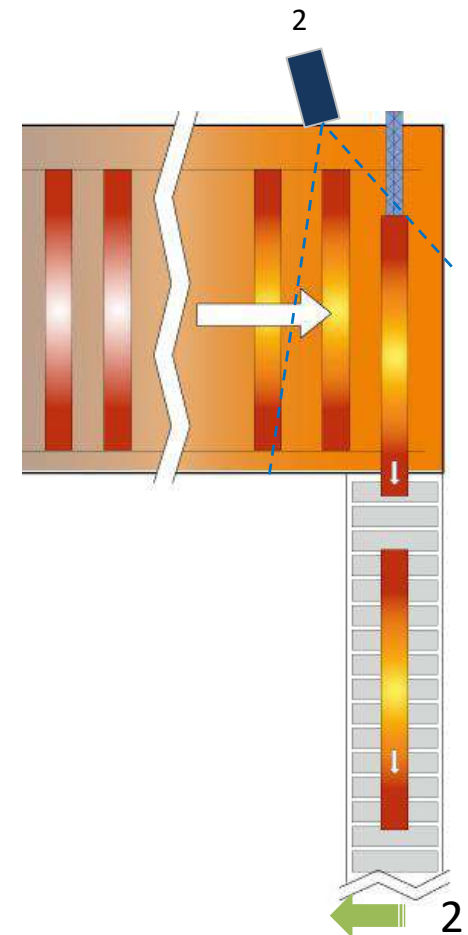

- Resistant to:
 - High temperature
 - High luminance

DISCHARGING SIDE INSTALLATION (RHF)

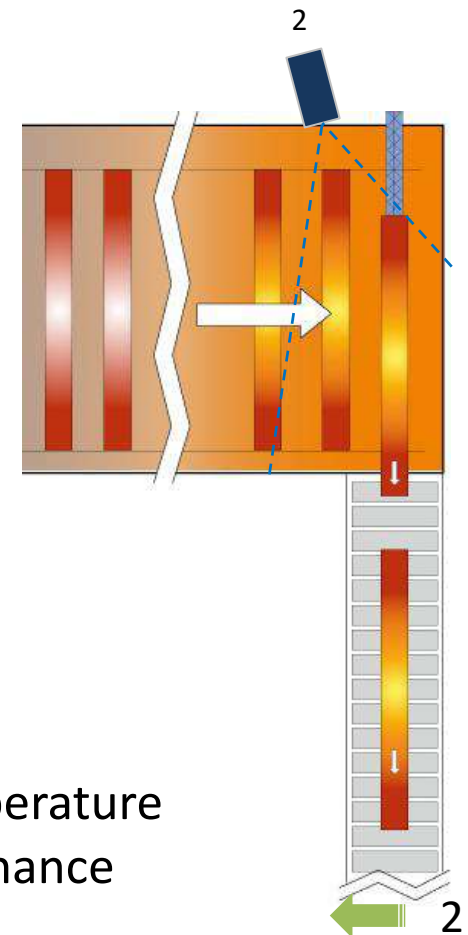

- Resistant to:
 - High temperature
 - High luminance

PEEL BAR (RHF)

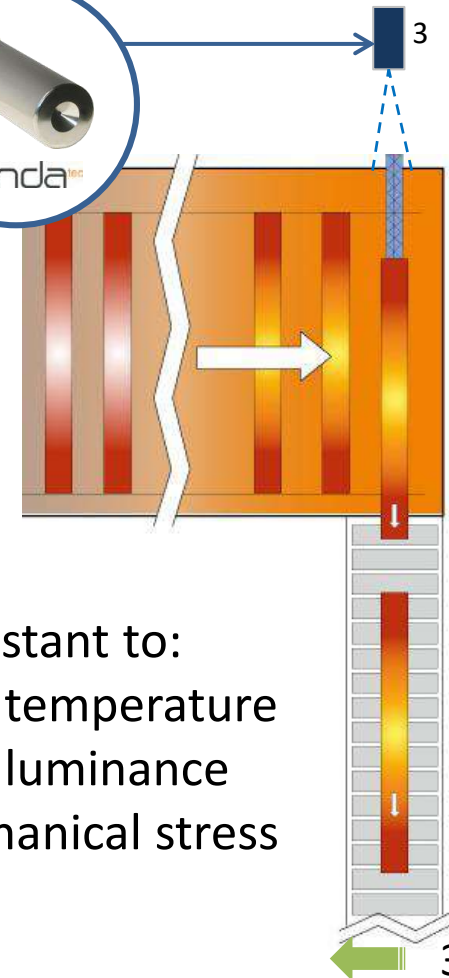

- Resistant to:
 - High temperature
 - High luminance
 - Mechanical stress

WAY OUT (RHF)

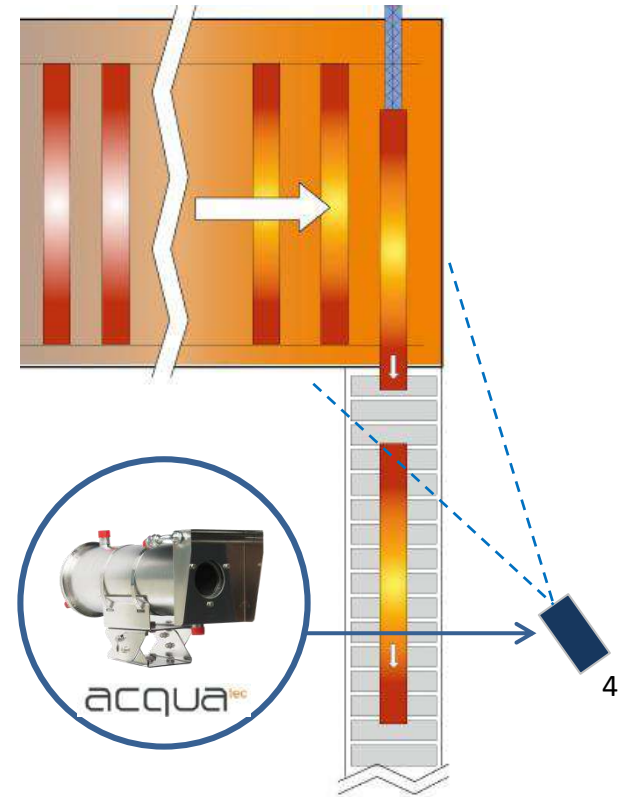

- Resistant to high luminance

TEMPERATURE MEASUREMENT of ANNEALING FURNACE DISCHARGE

Temperature measurement of annealing furnace discharge: An optimum temperature is necessary before rolling process. Defects would appear otherwise.



ROLLING MILL

Many other high temperature application are available for:

- Long products rolling mill
- Hot strip mill
- Wire/rod mill
- Pipe mill



ROLLING MILL

Thermal cameras are being used for thermal distribution control and detection of wire rods manufacture.

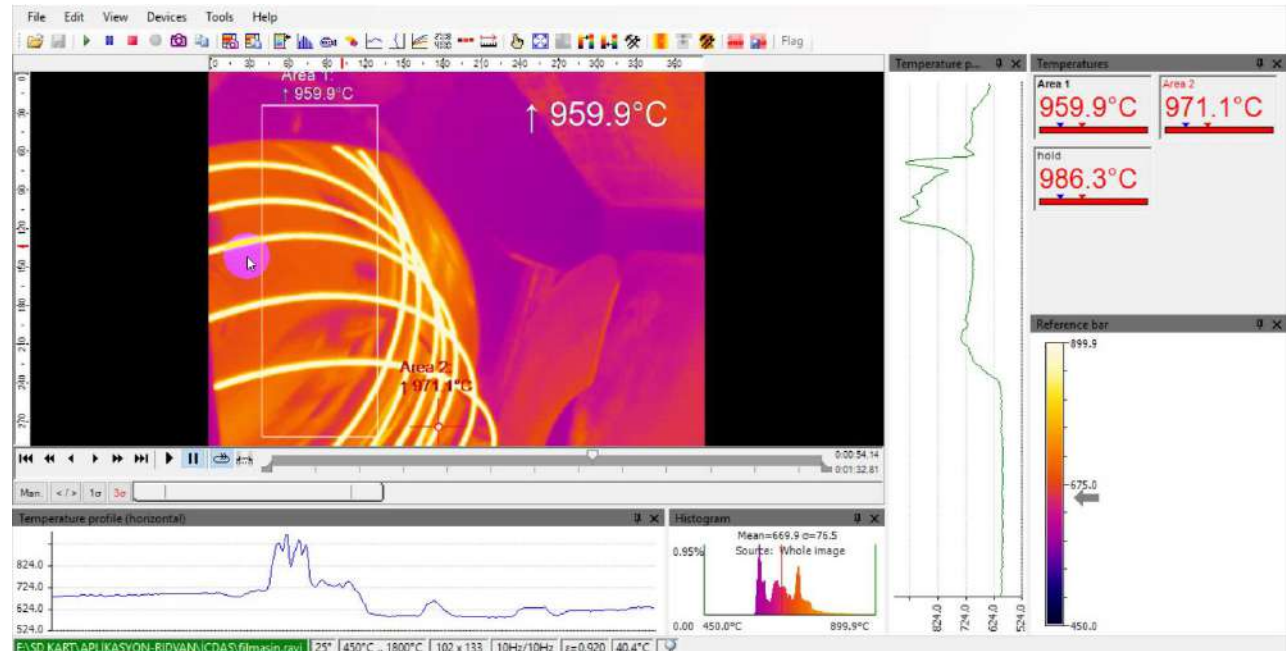

ELECTRICAL SUBSTATION MONITORING

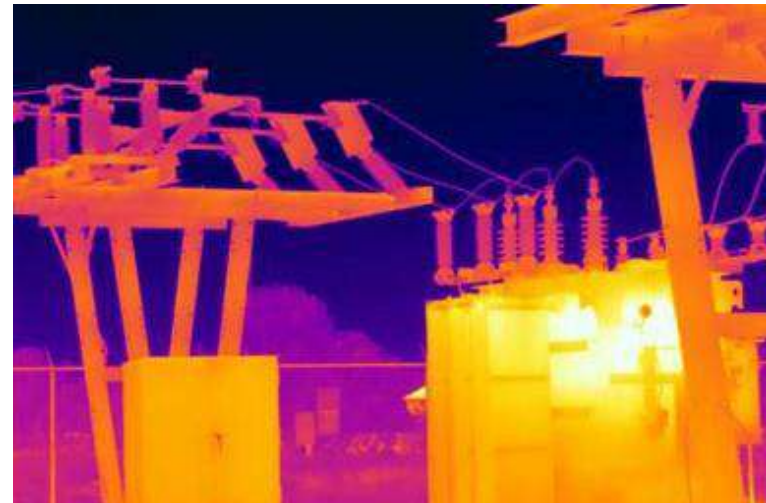

By using thermal imaging cameras and centralization software, impending equipment failures and security breaches can be detected anytime, day or night, at a remote monitoring location. The net effect is increased reliability and reduced cost.

MONITORAGGIO SOTTOSTAZIONE ELETTRICHE

KEY ADVANTAGES:

- Reliable 24/7 conditions monitoring of substations;
- Early detection of critical conditions by continuous analyzing of temperature trends;
- Automatic evaluation of thermal images and alarming for quickest possible danger prevention;
- Maintenance free operation;

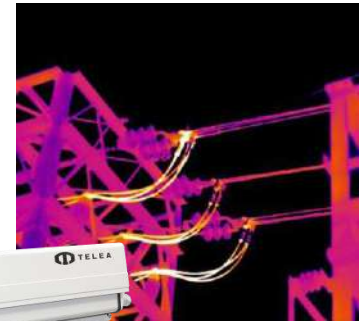
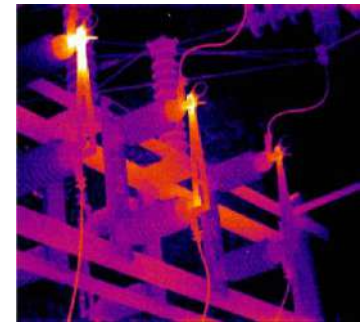

INDUSTRIAL CCTV SYSTEMS

APPLICATIONS

- Melt shop general supervision;
- Cold rolling mill general supervision;
- Trimming & Slitting line vision;
- Management control raw material (tapes, hoppers);
- Deposit control;
- Truck access and charging area;
- Perimeter control;

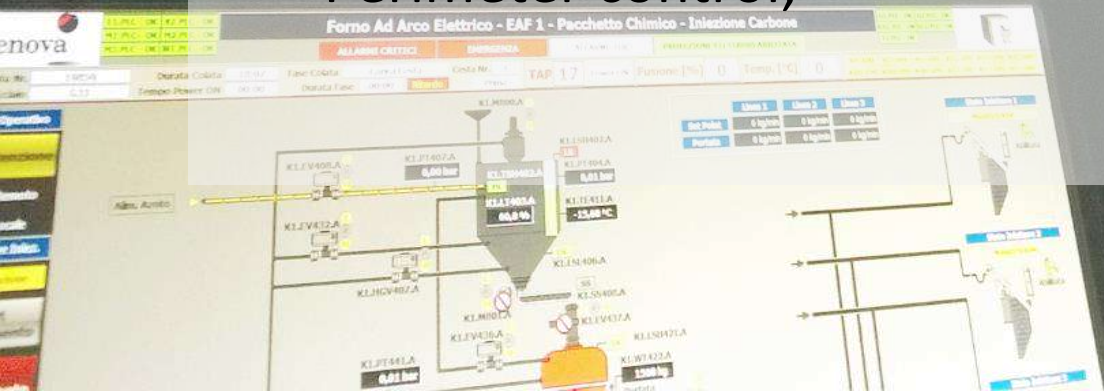

INDUSTRIAL CCTV SYSTEM

TECHNOLOGIES & PRODUCTS

- WIDE RANGE OF CAMERAS AND ACCESSORIES (ANALOG, IP, FIXED OR PTZ);
- SPECIAL HOUSING FOR DUSTY ENVIRONMENT



- WIFI TRANSMISSION FOR CAMERA ON CRANE;
 - LONG DISTANCE TRANSMISSION WITH FIBER OPTIC DEVICE



- COMPLETE SOLUTION FOR CONTROL ROOM VIDEO MANAGEMENT



INDUSTRIAL VIDEO MANAGEMENT SOFTWARE

Telea has developed “**Matrica**” a video management software that allow to manage view screens, functions menu and cameras command.

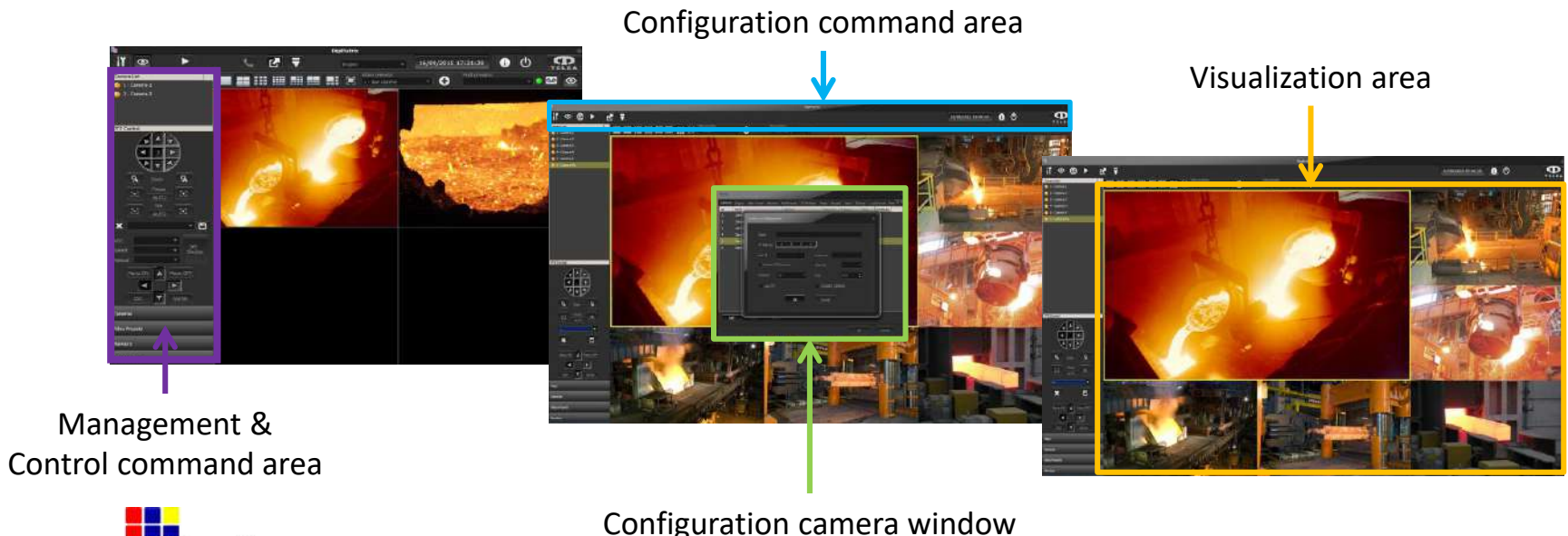
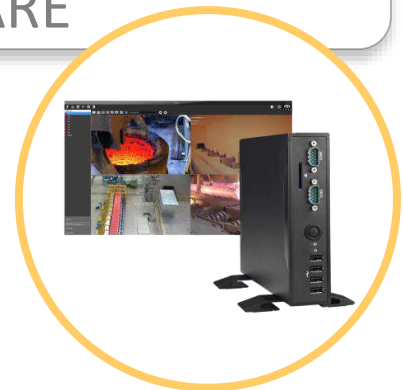

INDUSTRIAL VIDEO MANAGEMENT SOFTWARE

Digimatrix Shuttle is available in four different versions: *Base*, *Standard*, *Professional* and *Enterprise* in order to satisfy different functional and dimensional necessities; it is also available as *Decoder* version, in order to be used as virtual monitor.

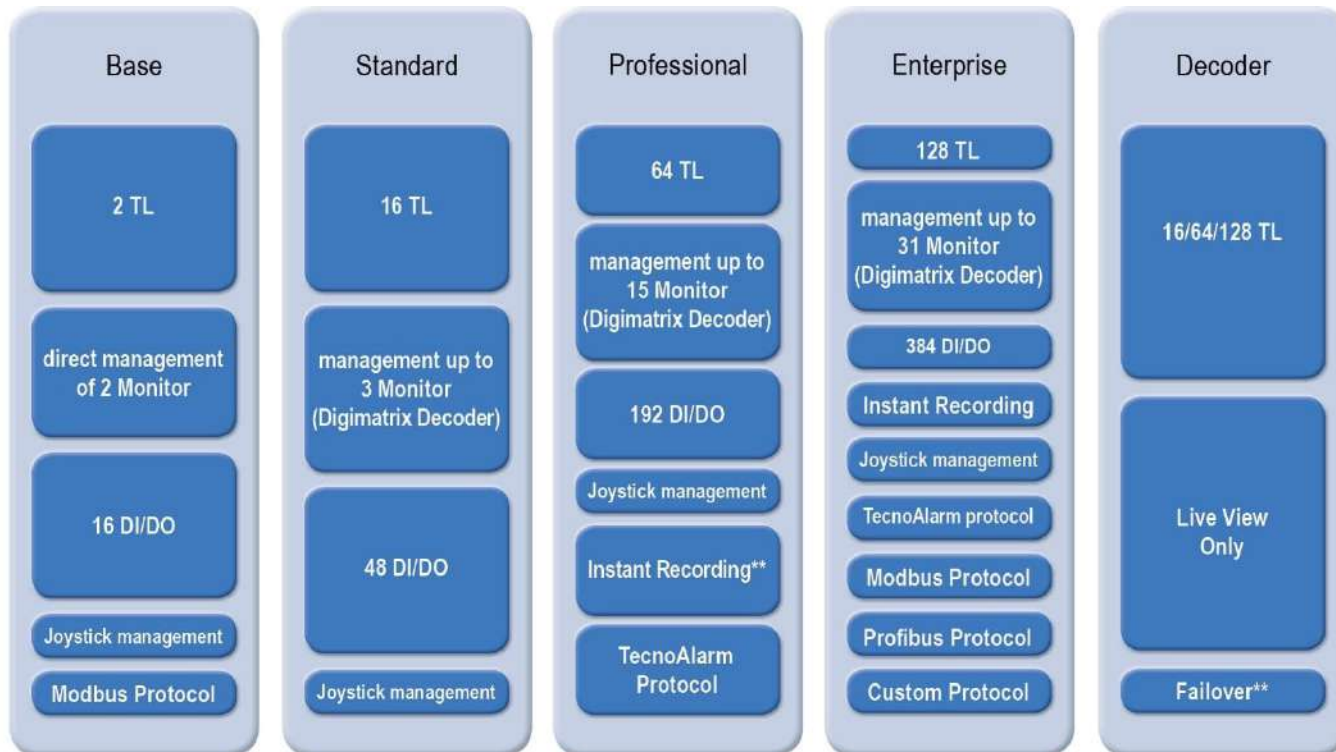

www.telea.com

** Functions available only with models: DMS_Pro7 and DMS_Dec7

INDUSTRIAL VIDEO MANAGEMENT SOFTWARE

KEY POINTS

- Full HD (1920x1080p) resolution at 30 fps (displayed on each monitor);
- Low latency on video streaming;
- Full flexibility;
- Multiple type of visualization;
- PEER to PEER video streaming architecture;
- PTZ camera preset management;
- Preset monitor management;
- Multi preset management;
- Commands acquisition;
- Interaction with process automation system;
- Instant recording function;
- Display of free text alerts;

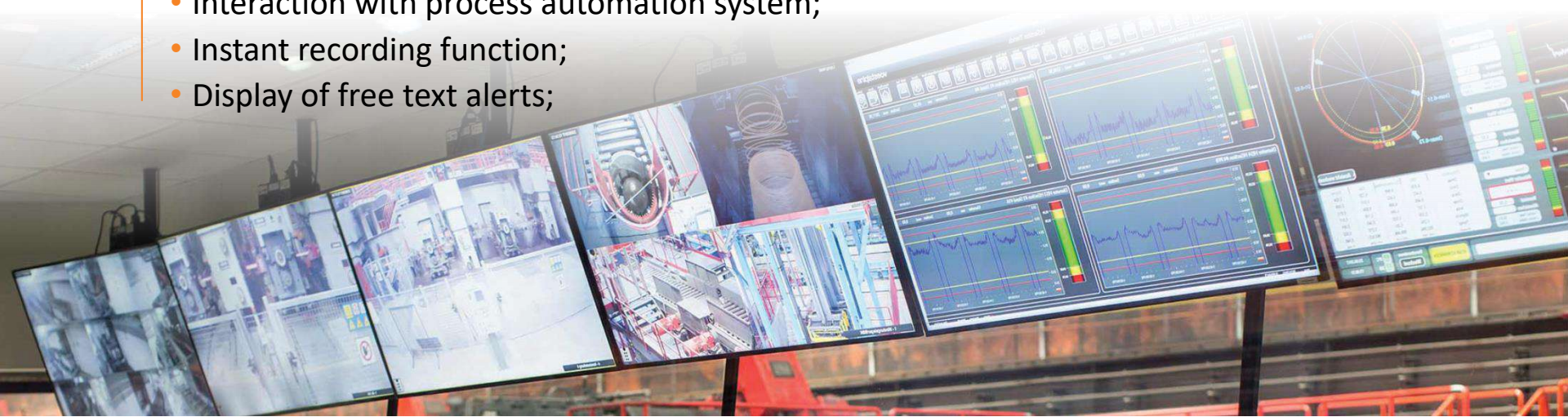

MATRICA EMBEDDED SOFTWARE

Matrica software use an intelligent display feature that allows to reduce time latency thanks to managing dynamically of camera streams, so reducing the resource required.

Modalità display*	1x1	1920 x 1080 @ 25fps
	2x2	680 x 360 @ 25fps
	3x3	
	4x4	



* Camera with double streaming feature is required

Matrica software is embedded inside **Telea Digimatrix**, a digital video matrix able to display and manage CCTV systems, based on TICP/IP technology.



INDUSTRIAL AUDIO COMMUNICATION

APPLICATIONS

- Heavy duty INTERPHONE for process area;
- PAGA – Public Address and General Alarm system for safety;
- Communication Crane to ground pulpit;
- Access and gate phone

INDUSTRIAL AUDIO COMMUNICATION

TECHNOLOGIES & PRODUCTS

- PUBLIC ADDRESS & GENERAL ALARM (PAGA)



- INDUSTRIAL TELEPHONY & RADIO COMMUNICATION



- INDUSTRIAL INTERCOM



MAPS OF OUR GLOBAL INSTALLATIONS

Industrial CCTV system for MEP (for Industeel Belgium) - STEP 1: VD/VOD/FP/TN	CAP Instrumentation	Belgium	2023
Materials for updating the intercom system steel mill	Acciaierie di Verona S.p.A.	Italy	2023
CCTV system for Rolling Mill plant (Brazil)	DANIELI AUTOMATION S.p.A.	Brazil	2023
Extraordinary maintenance of the CCTV system Granarolo plant Località Bologna	EUROTEC S.r.l.	Italy	2023
High temperature camera system for RHF [ANALOG]	DANIELI CENTRO COMBUSTION INDIA PVT. Ltd.	South Korea	2023
High temperature camera systems for RHF 80tph WBF	DANIELI CENTRO COMBUSTION INDIA PVT. Ltd.	Peru	2023
High temperature camera systems for RHF 100tph WBF	DANIELI CENTRO COMBUSTION INDIA PVT. Ltd.	Brazil	2023
CCTV system for new rolling mill	TRAVI E PROFILATI DI PALLANZENO S.p.A.	Italy	2023
High temperature camera system with INTEC device for Aluminum Melting Furnace (only air cooled - NEW release)	Mechatherm International Ltd	United Kingdom	2023
CCTV vision system for pusher furnace (similar to previous CO19/0134)	DANIELI CENTRO COMBUSTION S.p.A.	Honduras	2023
Revamping telecamere per CC1 cannelli	ABS - Acciaierie Bertoli Safau	Italy	2023
High temperature cameras for Forno Ona	ABS - Acciaierie Bertoli Safau	Italy	2023
High temperature camera system for HPDQ-BOF project	SMS Group GmbH	Vietnam	2023
CCTV & INTERCOM system - Integrated Auxiliary system for Suez Steel	SMS group S.p.A.	Egypt	2023
Steel plant CCTV system	ASONEXT S.p.A.	Italy	2023
Cameras for RHF Elti furnace area / BBK	STAHL GERLAFINGEN AG	Switzerland	2023
Materials for QWR department modifications	ABS - Acciaierie Bertoli Safau	Italy	2023
CCTV system for Walzwerk RM1 KombiStrasse, BBK unt SundBindemaschine	STAHL GERLAFINGEN AG	Switzerland	2023
High temperature camera systems for Habas Company (roughing mill section and down outer section)	OPTIK SENS ÖLÇÜM VE KONTROL SİS. MÜH. MÜM. SAN VE TIC. LTD. STI.	Turkey	2022
Guillotine protection device OUTEK. Bendotti Oven	COGNE ACCIAI SPECIALI S.p.A.	Italy	2022
Furnace TVCC system for 135 tph Walking Beams	AMB S.r.l.	Bangladesh	2022
Revamping telecamere acciaieria (forni VD / LF)	ABS - Acciaierie Bertoli Safau	Italy	2022
CCTV System for Scaw Metal WBF 120TPH Re-Heating Furnace	DANIELI CENTRO COMBUSTION INDIA PVT. Ltd.	South Africa	2022
High temperature camera system for RHF (billets)	SMS group S.p.A.	South Korea	2022

From Istanbul to Mexico and India to Egypt you can find Telea-Tecnovision's systems installed.

MAPS OF OUR GLOBAL INSTALLATIONS

High temperature cameras for Walking Beam oven	ABS - Acciaierie Bertoli Safau	Italy	2022
CCTV system for Cranes control in an automatic Meltshop Plant	DANIELI & C. Officine Meccaniche S.p.A.	Egypt	2022
High temperature camera system for Aluminum Melting Furnace (Sistem Teknik) – USA	OPTIK SENS ÖLÇÜM VE KONTROL SİS. MÜH. MÜM. SAN VE TIC. LTD. STI.	USA	2022
PTZ camera replacement - CCTV system for EAF control	LME Trith	France	2022
CCTV system for finishing area (Steel Plant)	SMS group S.p.A.	USA	2022
High temperature camera system for LF	Equisider S.L.	France	2022
Industrial IP cameras for internal control of the Bendotti oven	COGNE ACCIAI SPECIALI S.p.A.	Italy	2022
Video Matrix System - Final Destination: Canada	DANIELI AUTOMATION S.p.A.	Canada	2022
Industrial CCTV system for RHF (for TKSE)	DANIELI CENTRO COMBUSTION S.p.A.	Germany	2022
Stainless steel camera enclosures for classified area. Project II FREMM XI SHIP ITALIAN NAVY	Colibrì Video Insight S.r.l	Italy	2022
IR camera system for ladle refractory temperature monitoring (on crane) + Thermal imaging camera system for AOD monitoring	Aperam Stainless Europe	Belgium	2022
Vision system revamping for rolling mill and heating furnace department	NLMK Verona S.p.A.	Italy	2022
High temperature camera system for RH Plant JVML-RH2	SMS Group GmbH	India	2022
High temperature camera system for Calcium Carbide Furnace monitoring	SARRALLE STEEL MELTING PLANT, S.L.	Turkey	2022
High temperature camera system for VOD	SMS Group GmbH	India	2022
Thermal imaging camera system for External Tundish Temperature Measurement	DANIELI AUTOMATION S.p.A.	Ecuador	2022
Materiali FW: TU0R2327EA - Lucchini	TENOVA S.p.A.	Italy	2022
Spare parts - Integrated system - Ain Sukhna - Suez	IIC for Steel Plants Management	Egypt	2022
High temperature vision system for Walking Beam Furnace	Kaptan Group	Egypt	2022
High temperature camera system for RHF	SMS group S.p.A.	Brazil	2022
High temperature camera system for inside AF monitoring (for NLMK Clabecq)	CAP Instrumentation	Belgium	2022
Intercom system in the PK BOLZANO rolling mill department	CAP Instrumentation	Italy	2022

From Istanbul to Mexico and India to Egypt you can find Telea-Tecnovision's systems installed.

MAPS OF OUR GLOBAL INSTALLATIONS

CCTV system for MAIR line - Bolzano plant	Acciaierie Valbruna S.p.A.	Italy	2022
High temperature camera system for looking inside EAF (for customer: Magna)	MESUREX S.L.	Turkey	2022
Stainless steel camera enclosures for classified area. Project FREMM XI NAVE MARINA MILITARE ITALIANA	Colibrì Video Insight S.r.l	Italy	2022
CCTV system for crane control over furnace loading + High temperature camera system for Walking Hearth Furnace 110T/h	STAHL GERLAFINGEN AG	Switzerland	2022
Cameras for visual insufflation inspection in LF	LME Trith	France	2022
CCTV system for CCL plant	DANIELI AUTOMATION S.p.A.	Italy	2022
High temperature camera system for VD furnace	DANIELI & C. Officine Meccaniche S.p.A.	Canada	2022
High temperature camera system for VD furnace	Sarralle Equipment India Pvt. Ltd.	India	2022
CCTV system for new Grinding Machine	DANIELI AUTOMATION S.p.A.	India	2022
Modernization of CCTV system Rolling mill Lesegno	RIVA ACCIAIO S.p.A.	Italy	2022
Public Announcement and Communication System (P.A.) for DR Plant	PAUL WURTH ITALIA S.p.A.	Algeria	2022
Cameras and enclosures for oven Cremona	ACCIAIERIA ARVEDI S.p.A.	Italy	2022
CCTV system for Galvanizing line	DANIELI CENTRO COMBUSTION S.p.A.	Turkey	2022
Expansion system - New IP based cameras	DANIELI AUTOMATION S.p.A.	Israel	2022
Sistema TVCC per Linea di Molatura	DANIELI AUTOMATION S.p.A.	Italy	2022
High temperature vision system for Walking Beam Furnace (AFV Beltrame - Donalam)	Donalam S.r.l.	Romania	2022
Vision system for new rotary furnace + Flanged log with DN100 PN6 UNI EN 1092-1 to be welded to oven wall welding	LUCCHINI INDUSTRIES S.r.l.	Italy	2022
High temperature camera systems for VD furnaces	SARRALLE STEEL MELTING PLANT, S.L.	Unknow	2022
Sistema CCTV colata CC4 stabilimento Riva Caronno	ANTONIOLI Impianti elettrici S.r.l	Italy	2022
High temperature vision system for Walking Beam Furnace	DANIELI CENTRO COMBUSTION S.p.A.	Italy	2022
Spare parts high temperature analog camera system	INTERMETAL SA	Tunisia	2022
Renovation of the CCTV system pulpit LF	Acciaierie di Verona S.p.A.	Italy	2022
Vision system VD & Ladle refractory control system	ACCIAIERIA FONDERIA CIVIDALE S.p.A.	Italy	2022
High temperature camera system for JVML RH-SDE	SMS Group GmbH	India	2022

From Istanbul to Mexico and India to Egypt you can find Telea-Tecnovision's systems installed.



MAPS OF OUR GLOBAL INSTALLATIONS

Industrial IP cameras for revamping CCTV oven system	Officine Tecnosider S.r.l.	Italy	2022
High temperature IP camera system for EBT application monitoring + Additional electrical interconnection kit	HTT Engineering, spol. s r.o.	Czech Republic	2022
High temperature vision system for twin Ladle Furnace (LF)	DANIELI & C. Officine Meccaniche S.p.A.	Sweden	2022
High temperature camera system for EBT monitoring (EAF) + Thermal imaging camera system for Slag Detection	INTECO melting and casting techn. GmbH	China	2022
New oven cameras with IP technology	AGC FLAT GLASS ITALIA S.r.l.	Italy	2022
Additional materials - CCTV system for Rolling Mill (USA)	DANIELI AUTOMATION S.p.A.	Sweden	2022
Vision system for Galvanizing line	DANIELI CENTRO COMBUSTION S.p.A.	Italy	2022
CCTV system for furnace process monitoring	FORNI INDUSTRIALI BENDOTTI S.p.A.	Italy	2022
High temperature IP camera system for Pusher Type Furnace 50TPH Billet	SALALAH STEEL INDUSTRIES CO. LLC	Oman	2022
CCTV system for HDGL plant	DANIELI AUTOMATION S.p.A.	Italy	2022
IP version camera stations for 1&2 oven grid control	AZIENDA AMBIENTALE DI PUBBLICO SERVIZIO S.p.A.	Italy	2022
CCTV system for Spooler Line	DANIELI AUTOMATION S.p.A.	Spain	2022
High temperature vision system for twin Ladle Furnace (LF)	DANIELI & C. Officine Meccaniche S.p.A.	Sweden	2022
High temperature camera system for Slab Heating Furnace	SMS group S.p.A. / Severstal	Russia	2022
High temperature system for EBT monitoring (EAF) + Thermal imaging camera system for Slag Detection	INTECO melting and casting techn. GmbH	China	2022
Vision system for Galvanizing line	DANIELI CENTRO COMBUSTION S.p.A.	Italy	2022
CCTV system for oven process monitoring	FORNI INDUSTRIALI BENDOTTI S.p.A.	Italy	2022
High temperature IP camera system for Pusher Type Furnace 50TPH Billet	Raysut Steel Industries Co LCC	Oman	2022
CCTV system for HDGL plant	DANIELI AUTOMATION S.p.A.	Italy	2022
High temperature camera system for "Granella control application"	EUROMECC S.r.l.	USA	2021
CCTV cameras system for charge/discharge furnace arms monitoring	OPTIK SENS ÖLÇÜM VE KONTROL SİS. / Habas	Turkey	2021
Vision system for Galvanizing line	DANIELI CENTRO COMBUSTION S.p.A.	Italy	2021
High temperature camera system with Outec and Intec for RHF for Oksan Engineering	OPTIK SENS ÖLÇÜM VE KONTROL SİS. / Kardemir	Turkey	2021

From Istanbul to Mexico and India to Egypt you can find Telea-Tecnovision's systems installed.

MAPS OF OUR GLOBAL INSTALLATIONS

High temperature camera systems for EAF, EBT, Ladle sand filling and LF areas	SARRALLE STEEL MELTING PLANT, S.L.	USA	2021
CCTV system for EAF plant (Russia)	DANIELI AUTOMATION S.p.A.	Russia	2021
High temperature camera system for "Granella control application"	EUROMECC S.r.l.	China	2021
ORI Martin (BS) - High temperature camera system for VD/VOD furnace	SAMA S.r.l.	Italy	2021
High temperature cameras for VD furnace	ACCIAIERIA ARVEDI S.p.A.	Italy	2021
CCTV system for new Walking Beam Furnace 380t/h in TKSE Plant	TENOVA LOI Thermoprocess GmbH	Germany	2021
CCTV system for EAF plant (Russia)	DANIELI AUTOMATION S.p.A.	Russia	2021
High temperature camera system for "Granella control application"	EUROMECC S.r.l.	China	2021
ORI Martin (BS) - High temperature camera system for VD/VOD furnace	SAMA S.r.l.	Italy	2021
High temperature cameras for VD furnace	ACCIAIERIA ARVEDI S.p.A.	Italy	2021
CCTV system for new Walking Beam Furnace 380t/h in TKSE Plant	TENOVA LOI Thermoprocess GmbH	Germany	2021
Additional camera for firing axis for WBF	ABS - Acciaierie Bertoli Safau	Italy	2021
High temperature camera system for Reheating Furnace (WBF)	DANIELI CENTRO COMBUSTION S.p.A.	Russia	2021
Expansion system - Additional analog cameras - Project BPCOZN YEHUDA	DANIELI AUTOMATION S.p.A.	Israel	2021
Expansion system - High temperature camera system for Aluminum Melting Furnace	OPTIK SENS ÖLÇÜM VE KONTROL SİS. / Sistem Kompozit	Slovakia	2021
Thermal imaging camera for forged temperature control at the cut-off outlet	COGNE ACCIAI SPECIALI S.p.A.	Italy	2021
Thermal camera for casting wheel control	CARLO COLOMBO S.p.A.	Italy	2021
High temperature camera systems for EBT control	STRABLA S.r.l.	France	2021
Camera for second tank Argon control	COGNE ACCIAI SPECIALI S.p.A.	Italy	2021
CCTV system for scrap shredder plant & Non-Ferrous material processing plant	DANIELI & C. Officine Meccaniche S.p.A.	Italy	2021
Colour CCTV system for VD furnace	DANIELI & C. Officine Meccaniche S.p.A.	Russia	2021
High temperature IP based camera systems for VOD furnace and for EAF	Primetals Technologies Germany GmbH	Turkey	2021
High temperature camera systems for RH Vessel and for Ladle Treatment Station	Primetals Technologies Germany GmbH / Calvert	USA	2021

From Istanbul to Mexico and India to Egypt you can find Telea-Tecnovision's systems installed.

MAPS OF OUR GLOBAL INSTALLATIONS

System with thermal imaging cameras for Kobms converter refractory control	Acciaierie Valbruna S.p.A.	Italy	2021
High temperature vision system with retractable INTEC device for RHF	INGFRAMEX / Deacero	Mexico	2021
High temperature vision system designed for 4.0 interconnections	RINA Consulting - CSM S.p.A.	Italy	2021
High temperature camera system for Tempering Furnace	DANIELI CENTRO COMBUSTION S.p.A.	Ukraine	2021
High temperature camera system for Hardening Furnace	DANIELI CENTRO COMBUSTION S.p.A.	Ukraine	2021
High temperature camera system for VD furnace	SMS group S.p.A.	Peru	2021
CCTV system for inspection of the lamination preheating furnace (RHF)	DANIELI AUTOMATION S.p.A.	Ecuador	2021
Thermal imaging camera systems	SARRALLE STEEL MELTING PLANT, S.L.	Turkey	2021
High temperature camera system for RHF	NUOVA CARPENTERIA ODOLESE S.r.l.	Oman	2021
CCTV system for checking the addition of tubular ferroalloys wire	COGNE ACCIAI SPECIALI S.p.A.	Italy	2021
Vision system with thermal camera for DeSlag phase monitoring	ACCIAIERIE VENETE S.p.A.	Italy	2021
High temperature IP camera system for EBT	HTT Engineering, spol. s r.o.	Czech Republic	2021
Expansion CCTV system for Hot Strip Mill	DANIELI AUTOMATION S.p.A.	Vietnam	2021
IR camera system for temperature monitoring on Ladle Furnace	INTECO melting and casting techn. GmbH	Brazil	2021
High temperature camera for liquid steel bath monitoring in a LF	SCCM ALP	France	2021
High temperature camera systems for VD furnaces	SARRALLE STEEL MELTING PLANT, S.L.	Russia	2021
High temperature camera systems for LF and VD furnaces	SARRALLE STEEL MELTING PLANT, S.L.	Turkey	2021
Industrial cameras for EAF control	TENOVA S.p.A. Melt shops	China	2021
IP based CCTV system for Galvanizing Line + Additional cameras	TENOVA S.p.A.	France	2021
OPPEANO (VR) - Process camera System for VD furnace	TENOVA S.p.A. Melt shops	Italy	2021
CCTV system for Rolling Mill	DANIELI AUTOMATION S.p.A.	Italy	2021
CCTV system for new LF / VD furnaces	DANIELI AUTOMATION S.p.A.	Italy	2021
High temperature camera system for RHF (Walking Beam Furnace 167st/h)	DANIELI CENTRO COMBUSTION S.p.A.	USA	2021
High temperature camera system for viewing inside Aluminum Foundry Furnace	AUTOMAZIONI INDUSTRIALI CAPITANIO S.r.l.	Italy	2021
High temperature vision system for Slab Walking Beam Furnace (RHF)	SMS group S.p.A.	USA	2021
IP based CCTV system for Scrap Shredder Plant	Danieli UK Holding Ltd	Norway	2021

From Istanbul to Mexico and India to Egypt you can find Telea-Tecnovision's systems installed.

MAPS OF OUR GLOBAL INSTALLATIONS

Revamping high temperature camera system for EAF to IP technology	FERRIERA VALSABBIA S.p.A.	Italy	2021
Continuous casting control cameras for copper melting furnace	CARLO COLOMBO S.p.A.	Italy	2021
IP technology rolling mill train CCTV system restoration	COGNE ACCIAI SPECIALI S.p.A.	Italy	2021
High temperature vision system for aluminum melting furnace	One-Off Innovation S.r.l.	Italy	2021
High temperature camera systems for furnace processes control	FORNI INDUSTRIALI BENDOTTI S.p.A.	USA	2021
High temperature camera system for EBT control	EUROMECC S.r.l.	Serbia	2021
High temperature camera system for EBT control	EUROMECC S.r.l.	China	2021
High temperature vision system with pneumatic actuator for automated insertion and extraction	Acciaierie Valbruna S.p.A. / Olivotto	Italy	2021
Vision system for refractory oven burner control	FORNI INDUSTRIALI BENDOTTI S.p.A.	Guatemala	2020
High temperature IP camera system for Re-Heating Furnace monitoring	Ternium Atlantico	Colombia	2020
IP based Furnace High temperature CCTV system	OPTIK SENS ÖLÇÜM VE KONTROL SİS. / Habaş A.Ş.	Turkey	2020
High temperature vision system with OUTECC device	LME Trith	France	2020
CCTV system for stein cell line monitoring	COGNE ACCIAI SPECIALI S.p.A.	Italy	2020
Expansion CCTV system for slab caster area	DANIELI & C. Officine Meccaniche S.p.A.	Vietnam	2020
High temperature IP based camera system with Outec device	MARCEGAGLIA S.p.A	Italy	2020
Video matrix system (Sol. HW)	Danieli Automation S.p.A.	USA	2020
Expansion CCTV system for hot strip mill & coiling area	DANIELI & C. Officine Meccaniche S.p.A.	Vietnam	2020
Vision system for Sand Filling EBT (EAF) monitoring	SMS group S.p.A.	China	2020
Monitoring system for penstocks	Acciai Speciali Terni S.p.A.	Italy	2020
High temperature vision system for Steckel Furnace	Danieli Centro Combustion S.p.A. / Nucor	USA	2020
CCTV systems for a walking beam reheating furnace	Danieli Centro Combustion S.p.A.	Russia	2020
High temperature camera system for VAOD	SMS Group GmbH	Germany	2020
Audio Communication System for Hot Dip Galvanized Line	Danieli Automation S.p.A. / Tata Steel	UK	2020
High temperature vision system for twin Ladle Furnace (LF)	DANIELI & C. Officine Meccaniche S.p.A.	USA	2020
High temperature camera system for VD furnace	DANIELI & C. Officine Meccaniche S.p.A.	USA	2020
Thermal imaging camera for AOD monitoring	Acciaierie Valbruna S.p.A.	USA	2020
CCTV system for control of entrance/exit plates for the TAU rolling mill	Acciaierie Valbruna S.p.A.	Italy	2020
High temperature camera system for VD furnace	SMS Mevac GmbH / BÖHLER Steel Plant	Austria	2020

From Istanbul to Mexico and India to Egypt you can find Telea-Tecnovision's systems installed.



MAPS OF OUR GLOBAL INSTALLATIONS

CCTV system for PL lamination train + Cameras for heating furnace	Acciaierie Valbruna S.p.A.	Italy	2020
Thermal imaging cameras for refractory temperature control LF Tween	TRAVI E PROFILATI DI PALLANZENO S.r.l.	Italy	2020
High temperature vision system for EAF application	MESUREX S.L. / Magna	Spain	2020
Vision system for IDA – PIX	SO.IM.I S.r.l. / Acciai Speciali Terni	Italy	2020
High temperature camera system for VAOD	SMS Group GmbH / BÖHLER Steel Plant	Austria	2020
Customized housing development for EAF / Sharc oven interior vision	SMS Group S.p.A.	China	2020
Colour TV system for VD/VD-OB station	Danieli CO. Ltd.	Uzbekistan	2020
CCTV devices for existing system in slab caster plant	Danieli Automation S.p.A.	Russia	2020
High temperature IP based camera system with Outec device for RHF	Siderca S.A.I.C.	Argentina	2020
CCTV system for Rolling Mill	Danieli Automation S.p.A.	Russia	2020
System with industrial camera for vision oxygen lance insertion	Danieli Automation S.p.A.	Italy	2020
High temperature system for Submerged entry nozzle control (CCM)	MEGASA - SN SEIXAL S.A.	Portugal	2020
IR camera system for temperature monitoring on Ladle Furnace	INTECO melting and casting techn. GmbH	Brazil	2020
High temperature camera system with Outec device	OPTIK SENS ÖLÇÜM VE KONTROL SİS. MÜH. MÜM. SAN VE	Turkey	2020
Thermal imaging cameras for transformer control	FERRIERE NORD S.p.A.	Italy	2020
High temperature vision system for RHF	PT. Gunung Raja Paksi Tbk	Indonesia	2020
CCTV system for a rotary hearth furnace CPC0KAD1	Danieli Centro Combustion S.p.A. / OMK	Russia	2020
CCTV system for Tempering reheating furnace CPCK4D4	Danieli Centro Combustion S.p.A. / OMK	Russia	2020
CCTV system for Hardening reheating furnace CPCK4D2	Danieli Centro Combustion S.p.A. / OMK	Russia	2020
High temperature cameras for CCM3 cutting control	Acciai Speciali Terni S.p.A.	Italy	2020
High temperature camera system for VD furnace	SMS group S.p.A.	Sweden	2019
CCTV systems for 45T/H Pusher Type Furnace	AMB S.r.l. / Arabian Steel	Saudi Arabia	2019
High temperature camera system for Walking Beam (RHF)	DANIELI CENTRO COMBUSTION S.p.A.	Poland	2019
High temperature camera system for Walking Beam (RHF)	SO.IM.I. S.r.l.	Italy	2019
High temperature camera system for CCM	RIVA ACCIAIO S.p.A.	Italy	2019
High temperature camera system for EBT control	Sarralle Equipos Siderurgicos S.L.	Poland	2019
High temperature vision system for Steelwork	SMS group S.p.A.	Peru	2019
High temperature system for Walking Beam + Camera for Peel Bar	SIDER ENGINEERING S.p.A.	Serbia	2019
High temperature camera system for Walking Beam (RHF)	SIDER ENGINEERING S.p.A.	Morocco	2019

From Istanbul to Mexico and India to Egypt you can find Telea-Tecnovision's systems installed.

MAPS OF OUR GLOBAL INSTALLATIONS

High temperature vision system for Pusher Furnace	DANIELI CENTRO COMBUSTION S.p.A. / Aceros Alfa	Honduras	2019
High temperature camera system for EBT control	TRAVI E PROFILATI DI PALLANZENO S.r.l.	Italy	2019
BRESCIA - Expansion CCTV system for ribbons and hoppers	A2A Ambiente S.p.A.	Italy	2019
VALSABBIA - Process CCTV system for Rolling Mill	AUTOMAZIONI CAPITANIO S.r.l. / Ferriere Valsabbia	Italy	2019
Industrial CCTV system for Rolling Mill + CCM	SMS group S.p.A.	Oman	2019
Process CCTV system for VD Scaw Metals	Danieli & C. Officine Meccaniche	South Africa	2019
ST. PETERSBURG - High temperature camera system for DETEM Plant	INTECO melting and casting technologies GmbH	Russia	2019
High temperature camera system for Re-heating furnace	NUOVA CARPENTERIA ODOLESE S.r.l.	Italy	2019
High temp. camera with Recording system for Beam furnace RHF	JINDAL SHADEED IRON & STEEL Co. LLC	Oman	2019
High temperature camera system for Re-heating furnace	SMS group S.p.A.	Cameroon	2019
High temperature vision system for Pusher Furnace	CEA Group Srl	Mexico	2019
Industrial CCTV system for new CCM plant	Danieli & C. Officine Meccaniche	Turkey	2019
High temperature camera system for melten titan monitoring	GDX AS	Norway	2019
BOLZANO - Thermal and visible camera system for Electrical substation	Acciaierie Valbruna S.p.A.	Italy	2019
CCTV system for SCP + CTC + HCBC + CGT machines	PAUL WURTH ITALIA S.p.A./Severstal	Russia	2019
CCTV system for charging side and discharging side RHF	Danieli Centro Combustion / OEMK	Russia	2018
Vision system for crane & Expansion CCTV system for CC1, CC2, LF	TRAVI E PROFILATI DI PALLANZENO S.r.l.	Italy	2018
VERONA - Process CCTV and Audio Intercom for CCM 3	Acciaierie di Verona S.p.A.	Italy	2018
CCTV system for thin slab caster (CCM) + CCTV system for HSM	DANIELI & C. Officine Meccaniche S.p.A./unknown	Vietnam	2018
High temperature cameras for walking beam reheating furnace (RHF)	FORNI INDUSTRIALI BENDOTTI S.p.A./Arcelor Mittal	Canada	2018
VICENZA - CCTV system for control inside EAF Dog House	Acciaierie Valbruna S.p.A.	Italy	2018
VICENZA - Industrial Process CCTV for Rolling Mill T460B	Acciaierie Valbruna S.p.A.	Italy	2018
BOZEN - Reheating furnace	Acciaierie Valbruna S.p.A.	Italy	2018
CCM cutting CCTV system	COGNE ACCIAI SPECIALI S.p.A.	Italy	2018
Auxiliary Integrated System, for rolling mill (RM)	DANIELI & C. Officine Meccaniche S.p.A./Suez Steel SSC	Egypt	2018
VICENZA - High temperature cameras for reheating furnace (RHF)	FORNI E COMBUSTIONE S.r.l. / Acciaierie Valbruna	Italy	2018
ANNABA - CCTV process systems for hot rolling mill (RM)	DANIELI AUTOMATION S.p.A./ ETRHB	Algeria	2018
ANNABA - High temperature cameras for a reheating furnace (RHF)	DANIELI CENTRO COMBUSTION S.p.a/ ETRHB	Algeria	2018
High temperature cameras for walking beam reheating furnace (RHF)	SMS group S.p.A./unknown	Spain	2018

From Istanbul to Mexico and India to Egypt you can find Telea-Tecnovision's systems installed.

MAPS OF OUR GLOBAL INSTALLATIONS

High temperature cameras for walking beam reheating furnace (RHF)	DANIELI CENTRO COMBUSTION S.p.A./unknown	Usa	2018
High temperature cameras for a reheating furnace (RHF)	DANIELI CENTRO COMBUSTION S.p.A./AMKR	Ukraine	2018
BRESCIA - High temperature vision system for LF	SMS group S.p.A./ Travi e profilati Pallanzeno	Italy	2018
PADOVA - High temperature cameras for Walking Beam (RHF)	DANIELI CENTRO COMBUSTION S.p.A./Acciaierie Venete	Italy	2018
OSTRAVA - Thermographic camera system for synterization plant	EUROALARM, spol. s r.o./ Arcelor Mittal	Czech Republic	2018
Thermographic camera for leadle refractory control	FERRIERA VALSABBIA S.p.A.	Italy	2018
VICENZA - High temperature cameras for reheating furnace (RHF)	FORNI E COMBUSTIONE S.r.l. / Acciaierie Valbruna	Italy	2018
TERNI - CCTV system for CCM3	DANIELI AUTOMATION S.p.A./Thyssenkrup	Italy	2018
High temperature cameras for walking beam reheating furnace (RHF)	FORNI INDUSTRIALI BENDOTTI S.p.A. /Arcelor Mittal	Canada	2018
High temperature cameras for walking beam reheating furnace (RHF)	DANIELI CENTRO COMBUSTION S.p.A./unknown	Russia	2018
BRESCIA - High temperature vision system for LF	SMS group S.p.A./ Travi e profilati Pallanzeno	Italy	2018
Industrial CCTV system for EAF	TENOVA S.p.A. Melt shops	Cina	2018
High temperature cameras for walking beam reheating furnace (RHF)	FORNI INDUSTRIALI BENDOTTI S.p.A. / Unknow	Usa	2018
High temperature cameras for walking beam reheating furnace (RHF)	DANIELI CENTRO COMBUSTION S.p.A./unknown	Russia	2018
High temperature cameras for walking beam reheating furnace (RHF)	KTB Import-Export GmbH & Co. KG / Deacero	Mexico	2018
High temperature cameras for walking beam reheating furnace (RHF)	LME Trith	France	2018
High temperature cameras for walking beam reheating furnace (RHF)	DANIELI CENTRO COMBUSTION S.p.A./Jsw Steel	India	2018
BELLARA - Intercom System for DRI plant	PAUL WURTH ITALIA S.p.A./AQS	Alegeria	2018
CARONNO PERTUSELLA - Industrial CCV system for CCM 3	SAMA S.r.l./Riva acciaio	Italy	2018
Industrial process CCTV system for Cold Rolling Mill	SMS Group GmbH/unknown	Germany	2018
LOVERE - High temperature camera for VD	TENOVA S.p.A. Melt shops/Lucchini Ferroviaria	Italy	2018
VERONA - High temperature vision system for Reheating furnace	DANIELI CC S.p.A./Acciaieria di Verona	Italy	2017
CCTV System for Continuous Casting Machine	DANIELI AUTOMATION S.p.A./unknown	Italy	2017
CCTV System for Section Line	DANIELI & C. Officine Meccaniche S.p.A.	Italy	2017
TERNI - Industrial CCTV system for Acciai Speciali Terni plant	EL.TE. S.r.l./Acciai speciali Terni	Italy	2017
Expansion CCTV system for RHF	DANIELI & C. Officine Meccaniche S.p.A/Simec	Mexico	2017
CCTV System for slab Continuos Casting Machine in Galati Romania	DANIELI AUTOMATION S.p.A./unknown	Romania	2017
High temperature vision system for walking beam furnace	DANIELI CENTRO COMBUSTION S.p.a/unknown	Bolivia	2017
Cameras for on-board crane application	Danieli Centro Cranes S.p.A./unknown	Portugal	2017

From Istanbul to Mexico and India to Egypt you can find Telea-Tecnovision's systems installed.

MAPS OF OUR GLOBAL INSTALLATIONS

INTEC system for hollow glass furnace control	BDF Industries S.p.A./unknown	Italy	2017
High temperature cameras for walking beam furnace	FORNI INDUSTRIALI BENDOTTI S.p.A./Deacero	Mexico	2017
VERONA - High temperature cameras for continuous castel billet	DANIELI & C. Off. Meccaniche S.p.A./FerriereNord-Verona	Italy	2017
Industrial CCTV system for EAF control	LAMINES MARCHANDS EUROPEENS S.A.	France	2017
High temperature camera system with OUTEK protection device	SIDER ENGINEERING S.p.A./unknown	Italy	2017
High temperature vision system for Continuous Casting Machine	SMS group S.p.A./unknown	Italy	2017
Sistema TVCC per continuous castel billet 3	DANIELI & C. Officine Meccaniche S.p.A. / Ferriere Valsabbia	Italy	2017
High temperature vision system for Reheating furnace	SMS group S.p.A./unknown	Russia	2017
High temperature vision system for Reheating furnace	SMS group S.p.A./unknown	Russia	2017
Upgrade CCTV system for Dorr Oliver plant	SO.IM.I. S.r.l./Acciai Speciali	Italy	2017
CCTV & Intercom system	TENOVA S.p.A. Melt shops/unknown	Italy	2017
High temperature vision system for walking beam furnace	SMS group S.p.A./unknown	Italy	2017
High temperature vision system for Reheating furnace	SMS group S.p.A./unknown	Indonesia	2017
CCTV system for Continuous casting machine and Ladle Furnace	TRAVI E PROFILATI DI PALLANZENO S.r.l.	Italy	2017
High temperature CCTV system	AlJaber Int. Technical Trading (JITT) Co. / Qatar Steel	Qatar	2017
CCTV system with video matrix for LF/VD furnace	TENOVA S.p.A. Melt shops / Riva Acciai Lesegno (CM)	Italy	2017
High temperature vision system RHF furnace	SMS group S.p.A./unknown	Spain	2017
CCTV system with video matrix for LF/VD furnace	TENOVA S.p.A. Melt shops/unknown	Italy	2017
CCTV System for Section Line	DANIELI & C. Officine Meccaniche S.p.A.	Luxemburg	2017
GALATI - CCTV System for slab continuous casting machine	DANIELI AUTOMATION S.p.A. / Arcelor Mittal	Romania	2017
High temperature vision system for RHF	SMS group S.p.A.	Spain	2017
CCTV system for continuous casting	DANIELI AUTOMATION S.p.A. / Acciaierie di Verona	Italy	2017
Intercom & CCTV system	TENOVA S.p.A. Melt shops / Thyssen Krupp	Italy	2017
Integrated system CCTV - Intercom - Clock system	Danieli & Officine meccaniche / IIC Steel Egypt	Egypt	2017
Russia - High temperature vision system for reheating furnace	Forni e Combustione S.r.l. / Evraz plc	Russia	2016
San Zeno (BS) - Vision system for VOD, LF, EAF furnaces	TRAVI E PROFILATI DI PALLANZENO S.r.l.	Italy	2016
High temperature camera system for "Granella control application"	Sarralle Equipos Siderurgicos S.L.	Spain	2016
High temperature camera for reheating furnace	VENTURI S.r.l. / unknown	Egypt	2016
Terni - Intercom system	EL.TE. S.r.l./ Acciai Speciali Terni	Italy	2016

From Istanbul to Mexico and India to Egypt you can find Telea-Tecnovision's systems installed.

MAPS OF OUR GLOBAL INSTALLATIONS

CCTV system for steckel furnace	FERRIERA VALSIDER S.p.A.	Italy	2016
CCTV system for Melt shop Rolling Mill	DANIELI & C. Officine Meccaniche S.p.A. / unknown	Mexico	2016
High temperature camera for reheating furnace	OPTIK SENS ÖLÇÜM VE KONTROL SİS. / unknown	Turkey	2016
CCTV system for VD/VOD furnace	Sarralle Equipos Siderurgicos S.L. / unknown	Unknown	2016
Vacuum video camera systems - IP solution	SMS group S.p.A. / unknown	Russia	2016
CCTV system for VD/VOD furnace	DANIELI & C. Officine Meccaniche S.p.A. / unknown	Mexico	2016
High temperature vision system	SMS group S.p.A. / unknown	Russia e Romania	2016
High temperature vision system for tempering and quenching furnace	SMS group S.p.A. / unknown	Austria	2016
Sarezzo - High temperature for reheating furnace	AUTOMAZ. IND. CAPITANIO Srl / Acciaierie Venete Sarezzo	Italy	2016
High temperature camera for reheating furnace	STS Selected Technological Supplies s.r.l. / unknown	UAE	2016
Osoppo (UD) - Sistema VOD/VD per Ferriere Nord Pittini	TELESYSTEM / unknown	Italy	2016
Gate intercom system	AFERPI - Acciaierie e Ferriere di Piombino S.p.A.	Italy	2016
Potenza - Security plant CCTV system	FERRIERE NORD S.p.A.	Italy	2016
EAF process high temperature vision system	Sarralle Equipos Siderurgicos S.L. / unknown	Spain	2016
CCTV system for VOD furnace	DANIELI & C. Officine Meccaniche S.p.A. / unknown	Turkey	2016
Bozen - Process CCTV system for CCM	Acciaieria Valbruna Spa	Italia	2016
Rolling Mill 2-3 Integrated Auxiliary Systems	DANIELI & C. / Algerian Qatar Steel	Algeria	2016
CCTV system for VOD	Tenova S.p.A. / Acciaieria Arvedi	Italy	2016
CCTV system & control room videowall management for Blast Furnace	Paul Wurth S.A..	India	2016
Rolling Mill 1 Integrated Auxiliary Systems	DANIELI & C. / Algerian Qatar Steel	Algeria	2016
Integrated System	Danieli / NATIONAL PORT SAIID STEEL EGYPT	Egypt	2016
Integrated System	DANIELI & C. Officine Meccaniche S.p.A.	Turkey	2016
Riyadh - Walking hearth furnace	AL-Badeha For Metal Works / Watani Steel	KSA	2015
High Temperature Camera for EAF Tapping	COGNE ACCIAI SPECIALI S.p.A.	Italy	2015
CCTV system for reheating furnace	Danieli Centro Combustion	Algeria	2015
High Temperature Camera for Pusher Type furnace	SMS MEER	KSA	2015
High Temperature Camera for Discharging zone	STG Group S.p.A.	Tunisia	2015
High Temperature Camera for EAF Tapping	COGNE ACCIAI SPECIALI S.p.A.	Italy	2015
Industrial camera for pusher type furnace	Forni Industriali Bendotti	Unknown	2015

From Istanbul to Mexico and India to Egypt you can find Telea-Tecnovision's systems installed.

MAPS OF OUR GLOBAL INSTALLATIONS

Tenaris Bay City - Industrial cam. for Austenitizing & Temp. Furnace	Tenova Melt Shops / Tenaris	USA	2015
CCTV for Trimming Line	Danieli Automation	Unknown	2015
Dörtyol - Cold reversing mill & continuous pickling line	Danieli Automation S.p.A. / Atakaş Metallurgy	Turkey	2015
CCTV system for a Walking Beam Furnace	Danieli Centro Combustion	Argentina	2015
Color CCTV system for VOD	Danieli & C. Officine Meccaniche S.p.A.	Egypt	2015
OUTEC camera system for reheating furnace	Tenaris Tamsa	Mexico	2015
High temperature camera for walking beam furnace	Forni Industriali Bendotti / CMC Steel	USA	2015
Texas - High Temperature Camera for reheating Furnace	SMS Meer	India	2015
Marabá Pará - CCTV system for reheating furnace at discharging side	Danieli Centro Combustion S.p.A. / Sinobras	Brasil	2015
CCTV system for Rolling Mill & CCM Plant	DANIELI CZECH ENGINEERING A.S.	Israel	2015
Furnace CCTV system	SMS MEER	Czech	2015
Aliaga - Rolling Mill CCTV system	Ozkan Demir Celik	Turkey	2015
Riyadh - Walking hearth furnace	AL-Badeha For Metal Works / Watani Steel	KSA	2015
Neyshabur - Complete melt shop CCTV System	Khorasan Steel Plant	Iran	2015
Ciudad - Walking Beam Furnace	SMS MEER S.p.A. / Siderurgica Nacional	Venezuela	2015
Reheating Furnace	SIEMENS S.p.A. / ARBZ LLP	Kazakhstan	2014
Stockholm - CCTV System for Continuous Casting Machine	Saralle Equipos Siderurgicos S.L. / Ovako BAR AB	Sweden	2014
Abu Hashima - Mircromill	Danieli & C. Officine Meccaniche S.p.A. / Egyptian Steel	Egypt	2014
Sari - CCTV system for reheating furnace	CTS Demir Celik	Iran	2014
Reheating furnace	Danieli Centro Combustion S.p.A.	Brasil	2014
San Zeno - Integrated security systems for Iron & Steel plant	Travi e Profilati di Pallanzeno S.r.l. (Duferdofin Group)	Italy	2014
Rasht - Furnace high temperature camera	Forni Industriali Bendotti S.p.A. / Gilan Steel Complex	Iran	2014
Huston - CCTV System for Tempering Furnace	Danieli Centro Combustion S.p.A.	USA	2014
Brescia - Walking beam furnace	Forni Industriali Bendotti S.p.A. / ORI Martin S.p.A.	Italy	2014
China - Rolling Mill & Melt Shop	Danieli Changshu Metallurgical	China	2014
High temperature camera for LF	Tenova S.p.A. Melt shops / Safa Industrial Group	Iran	2014
Pusher furnace	Forni e Combustione S.r.l.	Ukraine	2014
Padova - CCTV system to control the bloom progress	Acciaierie Venete	Italy	2014
THAICHIN 2 project - CCTV & Intercom system	Danieli CO. Ltd. / Thaichin steel	Myanmar	2014

From Istanbul to Mexico and India to Egypt you can find Telea-Tecnovision's systems installed.

MAPS OF OUR GLOBAL INSTALLATIONS

Bangladesh – CCTV System for Rolling Mill	Danieli & C. Officine meccaniche S.p.A.	Bangladesh	2014
Walking beam 100 t/h project	FORNI INDUSTRIALI BENDOTTI S.p.A. / Sohar Steel	Oman	2014
Brescia - Electric Arc Furnace	ORI Martin S.p.A.	Italy	2014
Texas - Furnace high temperature camera	SMS MEER S.p.A. / Prolamsa	USA	2014
Đồng Nai - Galvanizing line & color coating line	Tenova S.p.A. Melt shops / SSSC	Vietnam	2014
CCTV System for charging side and discharging side	Danieli Centro Combustion S.p.A.	Mexico	2014
Pozzuolo del Friuli - CCTV system for reheating furnace	Danieli Centro Combustion S.p.A./ Acciaierie Bertoli Safau	Italy	2014
Kalinganagar - Reheating furnace	Tenova S.p.A. / Tata Steel	India	2014
Furnace TVCC System for reheating furnace	Danieli Centro Combustion S.p.A.	Russia	2014
VD/VOD Vacuum Degassers	Danieli & C. Officine Meccaniche S.p.A.	China	2014
High temperature camera for LF	Tenova S.p.A. Melt shops / Arcelor Mittal	Netherlands	2014
Caronno - Electric arc furnace	Gruppo Tibb S.r.l. / Riva Acciaio Spa	Italy	2014
Aliaga - Reheating furnace	Ozkan Demir Celik	Turkey	2013
CCTV system on "Crane"	Danieli Centro Cranes S.p.A.	Mexico	2013
DANAPUR HOSPET - Walking beam furnace 160 t/h	TENOVA S.p.A. / BMM ISPAT LTD	India	2013
IZMIR - Walking beams furnace inside/outside view	Habas Sinai ve Tibbi Gazlar Istihsal Endustrisi	Turkey	2013
LESEGNO - CCTV system on "Crane"	Euromec S.r.l. / Riva Acciaio	Italy	2013
LF Furnace 300 t/h	Tenova/Acelor Mittal	Belgium	2013
Melt Shop Process CCTV systems	SMS Concast Italia S.p.A.	France	2013
MONTREAL - Reheating Furnace	ArcelorMittal Montréal Inc.	Canada	2013
Process CCTV systems	SMS MEER S.p.A.	Russia	2013
Process CCTV systems	Danieli CO. Ltd. / POSCO	Vietnam	2013
Puscher Furnace	Forni e combustione	Ukraine	2013
Recycling area	Danieli & C. Officine Meccaniche S.p.A.	Germany	2013
Reheating furnace	SMS MEER S.p.A.	USA	2013
Reheating furnace	C.E.A. S.r.l.	Mexico	2013
Reheating furnace	DANIELI CENTRO COMBUSTION S.p.A.	Spain	2013
Reheating furnace 110 tph	STG Group S.p.A.	Iran	2013
Rolling Mill	SMS MEER S.p.A. / South Steel	KSA	2013

From Istanbul to Mexico and India to Egypt you can find Telea-Tecnovision's systems installed.

MAPS OF OUR GLOBAL INSTALLATIONS

Rolling Mill CCTV system	Danieli & C. Officine Meccaniche S.p.A.	Libya	2013
Rolling Mill Equipment - Process CCTV system	SIDERIMPES S.r.l. / KWTSTEEL	Kuwait	2013
Rolling Mill Intercom System	SIDERIMPES S.r.l. / KWTSTEEL	Kuwait	2013
SANGAN - Telephone System	Danieli & C. Officine Meccaniche S.p.A.	Iran	2013
Upgrade of Reheating furnace	Libyan Iron & Steel Company - LISCO	Libya	2013
VERONA - Process CCTV system	TENOVA S.p.A. / Riva Acciaio	Italy	2013
VICENZA - Reheating furnace	FORNI INDUSTRIALI BENDOTTI S.p.A. / Valbruna	Italy	2013
Walking heart furnace 100 t/h	DANIELI CENTRO COMBUSTION S.p.A.	Thailand	2013
ARGENTINA - Reheating furnace	SMS Meer	Argentina	2012
EBT sand charging system	TENOVA S.p.A. / IVACO Rolling Mills	Canada	2012
BRASIL - Rolling Mill	Danieli Officine & C. / Gerdau	Brasil	2012
BRASIL - Rolling Mill	Danieli Officine & C.	Brasil	2012
Kingdom of Bahrain - Reheating furnace	SMS Meer / United Steel Company [SULB]	Bahrain	2012
MEXICO - Reheating furnace	SMS Meer	Mexico	2012
MYANMAR - Intercom System	Danieli & C. Officine Meccaniche S.p.A.	Myanmar	2012
MYANMAR - Process CCTV system	Danieli & C. Officine Meccaniche S.p.A.	Myanmar	2012
MYANMAR - Rolling Mill CCTV system	Danieli & C. Officine Meccaniche S.p.A.	Myanmar	2012
OMAN - VD/VOD Vacuum Degassers	Danieli Co. Ltd / Shaded Iron & Steel Co. Ltd	Oman	2012
RUSSIA - Reheating furnace	SMS Meer	Russia	2012
SPAIN - Iron&Steel Plant	Danieli Officine & C. / Metales de Navarra S.a.	Spain	2012
TURKEY - Reheating furnace	Forni e Combustione / Ozkan Demir Celik Sanayi A.S.	Turkey	2012
ABU DHABI - Integrated Steel Plants - Phase 2	Danieli Far East CO. Ltd. / Emirates Steel Industries	UAE	2012
Belo Horizonte - Rolling Mill # 3	Ansaldo Sistemi Ind., SMS / ArcelorMittal Montevade	Brasil	2011
BRASIL - Reheating furnace	SMS Meer / Arcelor Mittal	Brasil	2011
BRASIL - Rolling Mill	Ansaldo Sistemi Industriali / Arcelor Mittal	Brasil	2011
CANADA - Reheating furnace	Forni industriali Bendotti / Arcelor Mittal	Canada	2011
GENOVA - Reheating furnace	Forni industriali Bendotti	Italia	2011
KSA - Rolling Mill	Danieli Officine & C. / Rajhi Steel	KSA	2011
MARUBENI - Flame monitoring	Macchi/Ansaldo Caldaie	Singapore	2011

From Istanbul to Mexico and India to Egypt you can find Telea-Tecnovision's systems installed.

MAPS OF OUR GLOBAL INSTALLATIONS

MEXICO - Reheating furnace	Forni industriali Bendotti	Mexico	2011
MONLEVADE - Continuous caster	SMS Concast/Arcelor Mittal	Brasil	2011
PIOMBINO - Blast Furnace	Lucchini Piombino	Italy	2011
ROMANIA - Iron & Steel plant	Ansaldo Sistemi Industriali	Romania	2011
RUHRORT - Reheating furnace	SMS Meer / Arcelor Mittal	Germany	2011
RUSSIA - Reheating furnace	SMS Meer / Kaluca	Brasil	2011
UKRAINE - Pusher Furnace	Forni e combustioni	Ukraine	2011
EGYPT - Continuous caster billet	Danieli Officine & C.	Egypt	2010
EGYPT - Electric arc furnace	Danieli Officine & C.	Egypt	2010
EGYPT - DRI Plant	Danieli Officine & C.	Egypt	2010
GUSA - Continuous caster blooms	Danieli Officine & C.	Brasil	2010
MEXICO - Reheating furnace	Forni industriali Bendotti	Mexico	2010
MISURATA - Rolling Mill	Danieli Officine & C. / Libyan Iron and Steel	Libya	2010
PIOMBINO - Blast Furnace	Paul Wurth / Lucchini Piombino	Italy	2010
PIOMBINO - Truck Parking	Lami / Bertacci	Italy	2010
RUSSIA - VD/VOD Vacuum Degassers	Danieli Officine & C.	Russia	2010
SLOVAKIA - Roll Mill and Reheating Furnace	SMS MEER	Slovakia	2010
SYRIA - Reheating furnace	SMS MEER	Syria	2010
UDINE - Reheating furnace	Forni industriali Bendotti	Italy	2010
UDINE - VD/VOD Vacuum Degassers	Telesystem / ABS	Italy	2010
VALLESE DI OPPEANO (VR) - Blooms Reheating furnace	Metinvest / Ferriera Valsider	Italy	2010
VERACRUZ - Rotary Reheating Furnace	SMS Meer / Tenaris Tamsa	Mexico	2010
VERACRUZ - Walking Hearth Furnace 90t/h	SMS Meer / Tenaris Tamsa	Mexico	2010
BRESCIA - Continuous caster blooms	Danieli Officine & C. / ORIMARTIN	Italy	2009
HAMRIYAH - Roll Mill	SMS Meer / HAMRIYAH STEEL FZC	UAE	2009
LESEGNO - Walking Hearth Furnace 90t/h	Elti / RIVA ACCIAI	Italy	2009
NOVA STEEL - Pusher Furnace 70t/h	Forni Industriali Bendotti / NOVA STEEL C.O.	Thailand	2009
PADOVA - Continuous caster blooms	Danieli Officine & C / ACCIAIERIE VENETE	Italy	2009
SSF - Pusher Furnace 120 t/h	Forni Industriali Bendotti / S.S.F.	Taiwan	2009

From Istanbul to Mexico and India to Egypt you can find Telea-Tecnovision's systems installed.

MAPS OF OUR GLOBAL INSTALLATIONS

TERNI - Strip finishing process	ThyssenKrupp Acciai Speciali Terni	Italy	2009
VALDASTICO - Crane	Bonfanti / FORGITAL	Italy	2009
VALSABBIA - Pusher Furnace 100t/h	Forni Industriali Bendotti / FERRIERA VALSABBIA	Italy	2009
GERLAFINGER - Reheating furnace	Forni e Combustione / STHAL GERLAFINGEN	Switzerland	2008
MILAZZO - Walking Hearth Furnace 125t/h	Forni Industriali Bendotti / DUFERDOFIN	Italy	2008
OSPITALETTO (BS) - Minimill EAF	Danieli Officine & C. / STEFANA	Italy	2008
OSPITALETTO (BS) - Reheating furnace	SMS Meer / STEFANA	Italy	2008
PIOMBINO (LI) - Rolling Mill	Lucchini Piombino	Italy	2008
Reheating furnace	Forni e Combustione	Turkey	2008
Reheating furnace	SMS Meer	Russia	2008
Rolling Mill	SMS Meer	Russia	2008
THAILAND - Continuous casting	Concast	Thailand	2008
VD/VOD Vacuum Degassers	Danieli Officine & C.	Japan	2008
VERONA - Walking Hearth Furnace 125 t/h	Forni Industriali Bendotti / ACCIAIERIA GRIGOLI	Italy	2008
CHITTAGONG - Pusher Furnace 75 t/h	Forni Industriali Bendotti / BSRM STEEL	Bangladesh	2007
HUACIPATO - Walking Hearth Furnace 120 t/h	Forni Industriali Bendotti / CSH	Chile	2007
THEP VIET - Walking Hearth Furnace 90 t/h	Forni Industriali Bendotti / TEP VIET	Vietnam	2007
TOURUS - Reheating Furnace	Danieli Centro Combustion / Corus	UK	2006
VICENZA - Rolling Mill	Acciaierie Valbruna	Italy	2006
LA LOUVIERE - Push pull pickling line	Techint / Duferco	Belgium	2005
MESAIEED - Reheating furnace	Techint / Qatar Steel	Qatar	2005
SAN PAULO - Rolling Mill	Danieli & C. Officine Meccaniche / Gerdau	Brazil	2005
CIVIDATE AL PIANO (BG) - Vacuum degassing plant	Techint / Acciaieria di Cividate al Piano	Italy	2003
IL CAIRO - Rolling Mill	ABB	Egypt	1997

From Istanbul to Mexico and India to Egypt you can find Telea-Tecnovision's systems installed.